

**SOLVING THE "INTERMITTENT"**

# RADIO NEWS

39  
AUGUST  
25c

**ONE TUBE  
AUTO-RADIO  
CONVERTER**

**Inexpensive  
Perpetual  
Analyzer-  
Tube Tester**

*What's  
That  
Noise?*

**112-118 MC  
TRANSCEIVER**

**Freq. Monitor  
Receiver**

**PORTABLE  
VOLT-OHMETER**

**SERVICEMAN'S  
CASE HISTORIES**



**ULMER (W9UG) TURNER**  
— The Globe Trotter —  
Operating the \$5,000 RADIO NEWS  
"All-Purpose" Transmitter-Receiver



AMATEUR  
DIVISION  
63  
Cortlandt St.,  
New York, N.Y.

# DAVEGA

HAMMARLUND  
H. Q. 120  
HOWARD  
T E M C O  
TRANSMITTERS  
SARGENTMARINE  
PATTERSON  
GARRARD

WORLD'S LARGEST RETAIL RADIO DEALER

## ACR-111 COMMUNICATION RECEIVER

Single signal 16-tube Superheterodyne circuit. Two tuned r.f. stages, constant percentage electrical band speed, individual isolated oscillators, two I.F. amplifier stages, crystal filter, push-pull power output stage and an integral power supply.

Made to Sell  
for  
\$189.50

\$99<sup>50</sup>  
Limited  
Quantity

DAVEGA is America's Pioneer  
dealer in HALLICRAFTER

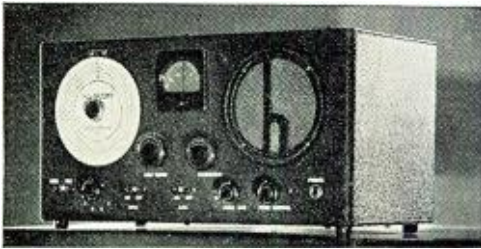

NEW HALLICRAFTER SKY-BUDDY: Full coverage for 10 meters including Broadcast Band • Four Bands • Electrical Band Spread • Full Size Chassis. Complete.....\$29.50



The NEW Skyrider DEFIANT—with FREQUENCY METER TUNING—a sensational new Hallicrafters receiver that represents one of the greatest values ever offered. Covers the radio spectrum from 43.5 to .54 MC with Electrical Band Spread on the 10, 20, 40 and 80 Meter Bands. Built-in Noise Limiter, 9 Tubes, Frequency Meter Tuning brings in signal as indicated on the frequency calibrated dial. Crystal Filter Circuit. \$69.50 including tubes and crystal but less speaker.

Davega has the largest stock of Hallicrafter  
Receivers and Transmitters in America

DAVEGA has the most complete  
Stock of RME in America

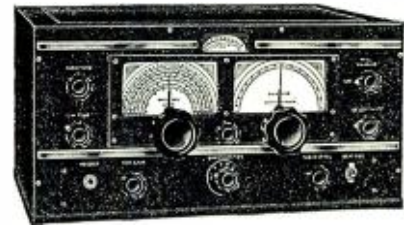

RME-70. The late development of RME laboratories is proving itself to be one of the finest communications receivers.

EASY  
TERMS

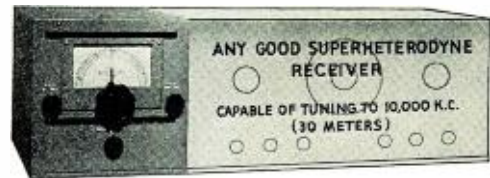

The DM-36. RME engineers again come through with a fine unit. This unit, in conjunction with a good medium frequency superheterodyne receiver provides the equivalent of low-frequency reception on 5 and 10 meters. The DM-36 is ready for your inspection at Davega.

DB-20 by RME. Signal amplifier, image rejector, guaranteed to improve any set enormously or your money refunded.

RME-69. The old standby of the communications world. A receiver which has proven itself to be dependable and faithful under any and all adverse circumstances.

RME Rack panel models. All types in stock.

SMASHING LOW PRICE!

## McMURDO SILVER 15-17

New r.f. amplifier equalizes gain at all wave lengths and provides in single stage, selectivity and gain heretofore available only in best two stage r.f. amplifiers. Four bands. Special Jensen-Silver 15" Giant electro-dynamic speaker. 30 to 8000 cycles. Heavy welded one piece chassis, 20" by 12 3/4".

Regular \$20500  
Price  
SALE \$10950  
You Save \$95.50

MCMURDO SILVER MASTERPIECE VI—Reg. Price \$355. Sale Price \$199.50

DAVEGA—63 CORTLANDT ST. (N.Y.C.)



**MAILING THIS COUPON**  
 has started hundreds  
 on the way to  
**BETTER PAY  
 IN RADIO**

MR. J. E. SMITH, PRESIDENT  
 NATIONAL RADIO INSTITUTE  
 DEPT. 9HR  
 WASHINGTON, D. C.

Dear Mr. Smith: Without obligation,  
 please send me a sample lesson and your  
 64 page book which points out spare time  
 and full time Radio opportunities and  
 those coming in Television, and shows  
 how I can train for Radio and Television  
 at home in spare time—about the N. R. I.  
 Set Servicing Instrument you give.  
 (Please write plainly.)

Name.....Age.....  
 Address.....  
 City.....State.....

14X-1

# You Can Train at Home for Radio and Television

Clip the coupon at the top of this page and mail it. I will prove I can train you at home in your spare time for RADIO AND TELEVISION. I will send you a sample lesson FREE. Examine it, read it, see how clear and easy it is to understand—how practical I make learning Radio and Television at home. Hundreds of men who did not have any Radio or electrical knowledge, now hold good Radio jobs, earn more money than ever before, as a result of my training.

**Why Many Radio Experts Make  
 \$30, \$50, \$75 a Week**

Radio broadcasting stations employ engineers, operators, station managers and pay well for trained men. Fixing Radio sets in spare time pays many \$200 to \$500 a year—full time jobs with Radio jobbers, manufacturers and dealers as much as \$30, \$50, \$75 a week. Many Radio Experts open full or part time Radio sales and repair businesses. Radio manufacturers and jobbers employ testers, inspectors, foremen, engineers, servicemen, in good-pay jobs with opportunities for advancement. Automobile, police, aviation, commercial Radio, loud speaker systems are newer fields offering good opportunities now and for the future. Television promises to open many good jobs soon. Men I trained have good jobs in these branches of Radio. Read how they got their jobs. Mail coupon.

**Many Make \$5, \$10, \$15 a Week Extra  
 in Spare Time While Learning**

The day you enroll I start sending Extra Money Job Sheets; show you how to do Radio repair jobs. Throughout your training I send plans and directions that made good spare time money—\$200 to \$500—for hundreds, while learning. I

send you special Radio equipment to conduct experiments and build circuits. This 50-50 method of training makes learning at home interesting, fascinating, practical. I devote more than 10 Lesson Texts exclusively to Television methods and applications, and cover Television fundamentals thoroughly in my Course.

**I Also Give You This  
 Professional Servicing Instrument**

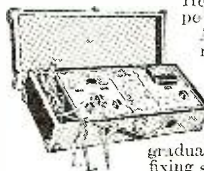

Here is the instrument every Radio expert needs and wants—an All-Wave, All-Purpose, Set Servicing Instrument. It contains everything necessary to measure A.C. and D.C. voltages and current; to test tubes, resistance; adjust and align any set, old or new. It satisfies your needs for professional servicing after you graduate—can help you make extra money fixing sets while training.

**Get Sample Lesson and 64 page Book  
 FREE—Mail Coupon**

In addition to my Sample Lesson, I will send you my 64-page book, "Rich Rewards in Radio." My book points out Radio's spare time and full time opportunities and those coming in Television; tells about my Training in Radio and Television; shows you letters from men I trained, telling what they are doing and earning; shows my Money Back Agreement. MAIL THE COUPON in an envelope, or paste it on a penny postcard.

**J. E. Smith, Pres., National Radio Institute  
 Dept. 9HR, Washington, D. C.**



**Truck Driver  
 Now Owns  
 Business**

Before taking the N. R. I. Course I was a truck driver making \$25 a week. Now I have my own Radio service shop and turn out up to \$500 of work a month. I recommend N. R. I. training. J. Alan Mohr, 2047 Fillmore St., San Francisco, Calif.

**Makes \$800  
 A Year  
 In Spare  
 Time**

I started to earn money about 3 months after enrolling with N. R. I. and made about \$600 before graduating. In the last 12 months I earned \$800 in spare time. S. G. Pierson, Dry Creek, W. Va.

**Sample Lesson FREE**

My sample lesson text, "Radio Receiver Troubles—Their Cause and Remedy," covers a long list of Radio receiver troubles in A.C., D.C., battery, universal, auto, T. R. F., superheterodyne, all-wave and other types of sets. And a cross reference system gives you the probable cause and a quick way to locate and remedy these set troubles. A special section is devoted to receiver check-up, alignment, balancing, neutralizing, testing. You can get this lesson Free by mailing the coupon.

**Specializes  
 in Aviation  
 Radio**

I am with the U. S. Signal Corps and specialize in Aviation Radio. I am on public address advice work. Any man can do N. R. I. Training. Claude L. Allday, 510 Hotwells Blvd., San Antonio, Tex.

**Income  
 Increased  
 \$1,000  
 A Year**

When I completed the N. R. I. Course I earned as much in spare time as I made from full-time factory work. I increased my income \$1,000 a year. John O. Husley, 24 E. High St., Bullfante, Penna.

**Had Own  
 Business  
 6 Months  
 After  
 Enrolling**

I went into business for myself 6 months after enrolling. In my Radio repair shop I do about \$300 worth of business a month. I can't tell you how valuable your Course has been to me. A. J. Baten, Box 581, Greggton, Texas.

**Turning  
 Point  
 In My Life**

Enrolling with N. R. I. was the turning point in my life. My job as Radio operator for the Ohio State Highway Patrol has given me security, and my earnings have doubled. Thomas B. Hedges, \$22, Beatty Ave., Cambridge, Ohio.



WITHIN

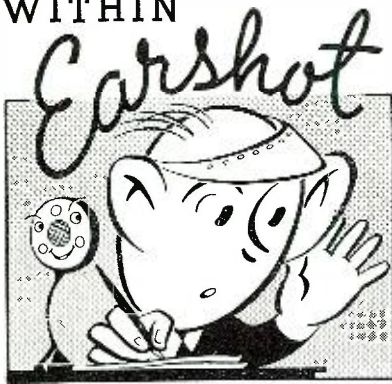

## OF THE EDITOR

For late there has been a marked degree of unrest attendant to the opening of official television programs in the East. Many dealers and servicemen have complained that the public is not buying big broadcast receivers, and that in fact they are not buying much of anything. All this, they blame on television.

An examination into the situation in Los Angeles, where television has been in being for the last 7 or eight years reveals that there has not been any falling off in the sales of sets. Then why should there be in the East?

We suspect that the root of the trouble lies in the lack of confidence which the dealers or servicemen display in their present products.

They are overwhelmed by the tremendous publicity which the high-powered corporations have given television, and instead of holding fast to the sound tenets of established radio selling business, they have allowed themselves to become *sold* on television so that with every sales talk a note of anxiety, a drachma of suspicion, an iota of doubt of the product creeps in. This cannot help but be transmitted to the customer, who in turn does not buy—even though he came into the store purposeful to own a good, high-priced radio broadcast receiver.

Significant it is, that even though they have been financed with over \$3,000,000 new capital, the new Farnsworth Radio & Television Corp. will start with the manufacture of fine *broadcast receivers*, and not television sets.

Don't let the publicity sway you away from the deeply implanted thought that broadcasting will *not* be supplanted by television for a long, long, long time. Go ahead and sell those high priced broadcast sets with complete confidence that you are not cheating your customer out of a possible television set. He won't need one for many years to come . . . at least at the expense of his aural enjoyment!

\* \* \*

**WE** are going to let you experimenters and radio hams in on a secret. We cannot reveal the big corporation which originated the idea, but for those of you who want to do  
(More Earshot on page 50)

# RADIO NEWS

Including Articles on POPULAR TELEVISION

The Magazine for the radio amateur experimenter, serviceman &amp; dealer

VOL. 22, NO. 2

## Contents for August, 1939

### FEATURES

- An Inexpensive Perpetual Analyzer-Tube Tester** . . . . . William H. Mitsch **6**  
The winning article in the \$150.00 prize contest.
- As I See It!** . . . . . John F. Rider **10**  
A full discussion of the tube discount problem.
- 1940 RADIO NEWS "All-Purpose" Transmitter-Receiver** . . . . . Karl A. Kopetzky, W9QEA, and Oliver Read, W9ETI **11**  
Exciter, VOX and speech amplifier construction explained. Part Two of Three.
- Solving the Intermittent** . . . . . "Tester" Bradley **16**  
An article on the serviceman's most serious problem. Part One of Three.
- One Tube Auto Radio UHF Converter** . . . . . McMurdo Silver **18**  
Enabling the reception of 5-10 meters signals with a car radio.
- 5-10-20 Meter Transmitter** . . . . . Frank C. Jones **20**  
New kinks and designs for a good amateur rig.
- What's That Noise?** . . . . . Charles Magee Adams **23**  
Tracing down the elusive QRN.
- A Freq.-Monitor Receiver** . . . . . R. F. Laycock **29**  
Including a frequency monitor in an all-band receiver.
- A Simple 112-118 MC. Transceiver** . . . . . M. N. Beitman **31**  
Exploring 2½ meters with a simple rig.
- A Portable Ohm Voltmeter** . . . . . R. K. Wheeler **33**  
Build this useful serviceman's instrument.
- Photographing Your Own Radio Set** . . . . . Henry F. Kroeger, Jr. **38**  
Simple instructions to make good technical radio pictures.

### DEPARTMENTS

- |                                |    |                              |    |                                    |    |
|--------------------------------|----|------------------------------|----|------------------------------------|----|
| Book Review . . . . .          | 32 | The Video Reporter . . . . . | 37 | Sight & Sound News . . . . .       | 35 |
| What's New in Radio . . . . .  | 24 | QRD? . . . . .               | 32 | Hamchatter . . . . .               | 25 |
| Radio Physics Course . . . . . | 60 | Bench Notes . . . . .        | 15 | Serviceman's Experiences . . . . . | 19 |
| Short Wave Flashes . . . . .   | 42 |                              |    | Serviceman's Cases . . . . .       | 40 |

Copyright, 1939  
ZIFF-DAVIS PUBLISHING COMPANY  
Member of the Audit Bureau of Circulations

RADIO NEWS is published monthly by the Ziff-Davis Publishing Company at 608 S. Dearborn St., Chicago, Ill. William B. Ziff, Publisher; B. G. Davis, Editor; Karl A. Kopetzky, Managing Editor; Oliver Read, Technical Editor; Herman R. Bollin, Art Director; John H. Reardon, Circulation Director; S. L. Cahn, Advertising Manager; New York Office, 381 Fourth Ave. Subscription \$1.50 per year; single copies, 25 cents; foreign postage \$1.00 per year additional except Canada. Entered as second class matter, March 9, 1938, at the Post Office, Chicago, Illinois, under the Act of March 3, 1879. Contributors should retain a copy of contributions. All submitted material must contain return postage. Contributions will be handled with reasonable care, but this magazine assumes no responsibility for their safety. Accepted material is subject to whatever adaptations and revisions necessary to meet requirements. Payment will be made at our current rates upon acceptance and, unless otherwise specified by the contributor, all photographs and drawings will be considered as constituting a part of the manuscript in making payment.

# BOOKS ON RADIO

ZIFF-DAVIS PUBLISHING COMPANY (Publishers of RADIO NEWS)  
offers these authoritative books on Radio

Every one written by an authority. Giving you in concentrated, easily assimilated form, the tested experience of practical Radio men, each an expert in his field. Why not add their experience to your own, and so increase your knowledge and earning power in this fascinating profession.

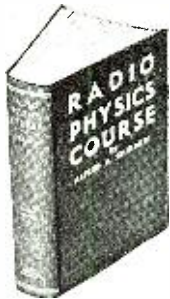

**RADIO PHYSICS COURSE (104)**  
By Alfred A. Ghirardi \$4.00

A book that leading radio schools throughout the world have chosen as the most thorough, instructive, and interesting radio book ever written—they use it as their basic text in their own radio courses. Explains in easy-to-understand language all of the essential facts about both electricity and radio from simple fundamentals to the most intricate applications. Invaluable to the radio beginner, Student, Serviceman. 972 pp., 508 illustrations, 856 self-review questions.

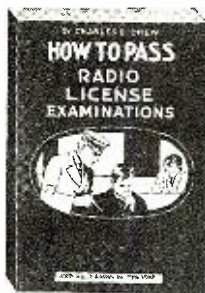

**HOW TO PASS RADIO LICENSE EXAMINATIONS (107)**  
By C. E. Drew \$2.00

(Third Edition in preparation.) A book directed to the professional operator. Explains fully all the questions that are met in taking the Federal Communications Commission's examinations for all classes of radio operator. Deals with the Radio Act and the Federal Communications Commission Rules and Regulations. The explanation of ship's radiotelephone and telegraphy and the method of handling traffic is one of the highlights.



**RADIO TROUBLE SHOOTER'S HANDBOOK (111)**  
By Alfred A. Ghirardi \$3.00

A new kind of servicing handbook. Essential data for your service jobs. A four-drawer filing cabinet could hardly hold all the mass of complex, technical servicing data that was assembled, tabulated, charted and indexed to make this the greatest contribution to Radio Servicing Literature ever published! 52 sections, 134 illustrations, 518 big 8½" by 11" pages.



**SERVICING RECEIVERS By Means of Resistance Measurements (112)**

By John F. Rider \$1.00  
Takes the guesswork out of servicing. How to use an ohmmeter in trouble shooting, and correctly interpret point to point resistance measurements. Vastly simplifies servicing problems. You will need this book to speed up your servicing accuracy. Let Rider show you how to use a modern servicing procedure on complicated receivers. Theory applied to practice. 203 pages.

**TELEVISION (117)**

By M. G. Scroggie \$1.50

Television, told in straightforward manner, for the professional or the amateur. A complete story of television, its methods, its mechanics, and its physics. Simple, easy-to-understand descriptions of the fundamentals of visual communication.

**FUNDAMENTALS OF RADIO (113)**

By F. E. Terman \$3.75

The basic principles of radio communication. A complete treatment of the subject of vacuum tubes and radio, covering the fundamentals of all important topics and the problems encountered in their practical application. Suitable for use in an introductory radio course. 458 pages, 6x9, 278 illustrations.



**RADIO OPERATING QUESTIONS & ANSWERS (114)**  
By Arthur R. Nilson & J. L. Hornung \$2.50

Over 600 questions and answers covering all radio operator license examinations. Questions are typical of those used on examinations; answers are full and well-illustrated. Includes information on broadcasting, marine, aeronautical, police and amateur radio operating. 427 pages, 5½x8, 106 illustrations.



**PRINCIPLES OF ELECTRICAL ENGINEERING (115)**  
By Timbie & Bush \$4.50

The Electrical Engineer. Electrical units and electric currents. Electric power and energy. The computation of resistance. Electrolytic conduction. The magnetic current. The magnetic field. Induced electromotive forces. Thermionic conduction and conduction through gases. Dielectrics. Many others. 595 pages. 270 figures.



**ELEMENTS OF RADIO COMMUNICATION (116)**  
By John H. Morecroft \$3.00

Simple laws of electric circuits. Laws particularly useful in radio communications. General idea of radio communication. The vacuum tube and its uses. Radio telegraphy. Radio telephony. Receiving sets. Problems. A simplified treatment of principles of radio communication not depending on mathematical knowledge. 286 pages 6x9.

Our book lists also present a wide variety on Photography, Aviation, Science

**IMPORTANT!**

Enclose remittance with order and we will prepay postage.

Check and mail this coupon TODAY. Add to your library the books you need, or secure information and prices on any book on Radio you may be interested in but which is not here listed. DO IT NOW before it slips your mind.

**CHECK YOUR CHOICE ON THIS COUPON**

Ziff-Davis Publishing Company, Book Department  
608 S. Dearborn St., Chicago, Illinois

R.N.7

Gentlemen: Please send me the books whose numbers I have encircled below.  
Book No. 104, 107, 111, 112, 113, 114, 115, 116, 117.

Price Enclosed \$.....  C. O. D. (Plus Postage)

Name .....

Address .....

City..... State.....



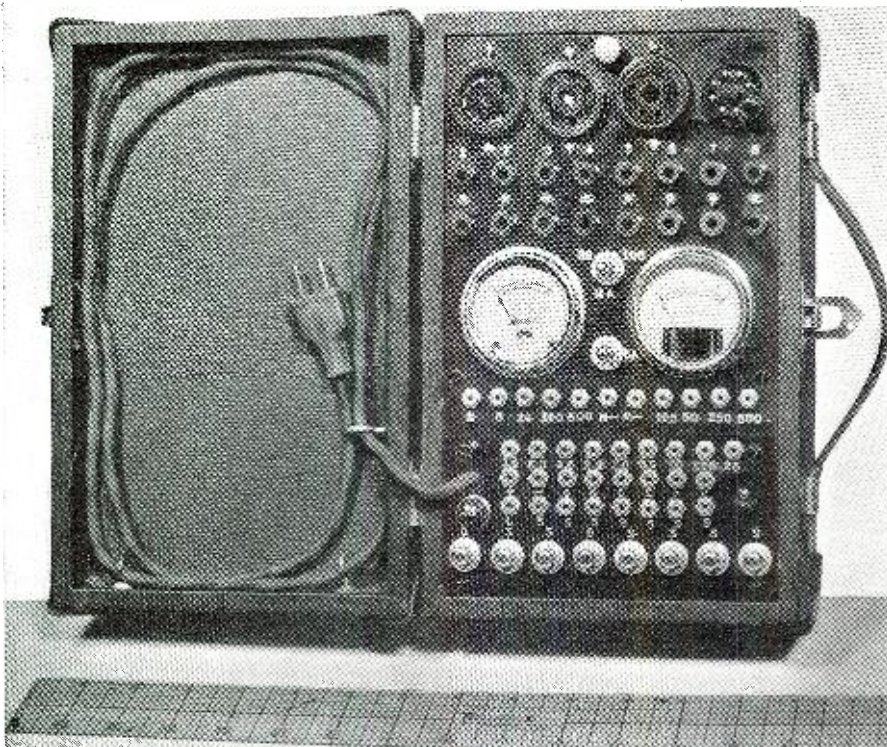

Note the compactness of the unit as compared to the ruler placed below.

# 1st. PRIZE WINNER OF \$150 CASH PRIZE CONTEST

By  
**WILLIAM H. MITSCH**  
Bethany Pike Woods, W. Va.

## Perpetual Analyzer-Tube Tester

*Here are full scale working drawings and plans for a tube tester that is also an analyzer. It is claimed that it will never be out-moded.*

### PRIZE WINNERS

- |  |  |
|--|--|
| 1st. William H. Mitsch, Bethany Pike Wds., Wheeling, W. Va.  | Honorable Mention  |
| 2nd. Ralph L. Stears, 208 Larkins Street, Findlay, Ohio.   | 1st. J. C. Kelley, Colebrook, N. H.                                      |
| 3rd. Glenn Haldeman, 16 Locust Avenue, Elkins, West Va.  | 2nd. Richard D. Jones, 209 Stonycreek St., Johnstown, Pa.                |
| 4th. Arthur Carlin, 871 Lill Avenue, Chicago, Illinois.  | 3rd. Glen Province, ex W5CGP, 310 Madison, Jonesboro, Arkansas.          |
| 5th. Robert J. Cartwright, 711½ Third Street, Menomonie, Wisconsin.                                      | 4th. Julius Greenblatt, 4603 Esplanade Avenue, Montreal, Quebec, Canada. |
| 6th. R. L. Miller, P. O. Box 1230, Midland, Texas.   | 5th. Rudie C. Bartel, R. F. D. No. 1, Box 49 A, Comfort, Texas.          |
| 7th. D. H. Marathe, VU2CU, Lamington Chambers, 2nd Fl., Lamington Road, Bombay 4, India, P. O. Box 3587. | 6th. H. Gordon Gwinn, 935 W. 21, Anderson, Indiana.                      |
| 8th. Henry H. Fincher, W4DCC, 1075 Sells Avenue, S. W., Atlanta, Ga.                                     | 7th. Merwyn Bly, W3FPL, Leesburg, Virginia.                              |
| 9th. Horace E. Eddy, W8MTZ, 3 Birch Street, Oneonta, N. Y.   | 8th. H. Gordon Gwinn, Box 55, Anderson, Indiana.                         |
| 10th. Edward Lovick, Jr., 2502 Harlan Street, Falls City, Nebraska.                                      | 9th.   |
| 11th. Samuel Procter, 707 W. Walnut Street, Louisville, Ky.  | 10th. Joseph H. Donsetter, 5240 Woodlawn Avenue, Chicago, Illinois.      |
| 12th. Jack A. Meeker, 1118 South St., Rapid City, So. Dak.   | Booby Prize: Robert X. Sheridan, 5151 Kenwood Ave., Chicago, Illinois.   |

**M**OST radio service instruments on the market today possess one or more of the following disadvantages:

- (1) They are not compact
- (2) They quickly become obsolete
- (3) They are not easily adapted to new tubes or circuits.

It was with the thought of overcoming these disadvantages that the design of this instrument was undertaken. This tester is housed in a case salvaged from a Readrite Model 406 tube tester. The upper section of the panel is removable to provide a space for carrying the cables and adapters. Referring to the wiring diagram, it can be seen that this instrument is divided into three separate units; namely, (1) the free point analyzer, (2) the volt-ammeter, and (3) the tube tester.

The free point analyzer needs no explanation, except to state that the old R.M.A. numbering system must be used on the combination sockets, because the heater prongs are common to the 4, 5 and 6 prong tubes.

The a.c.-d.c. volt-ammeter section also is self-explanatory. The shunts

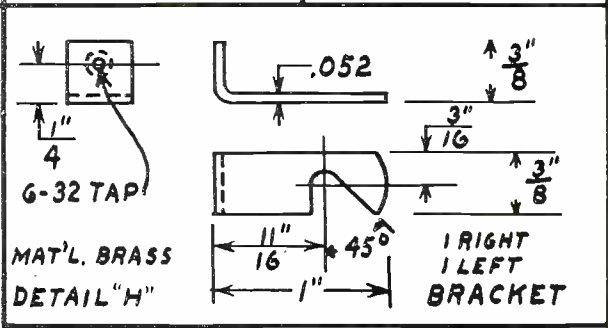
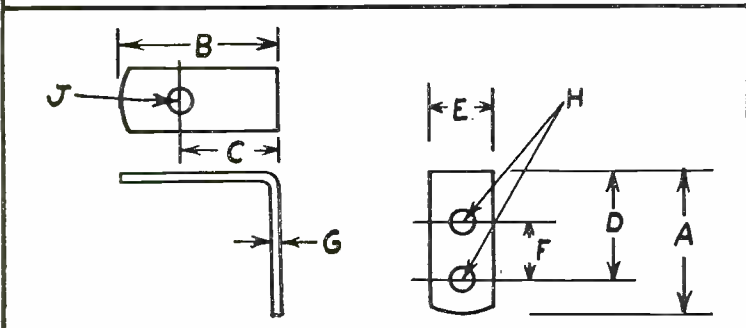
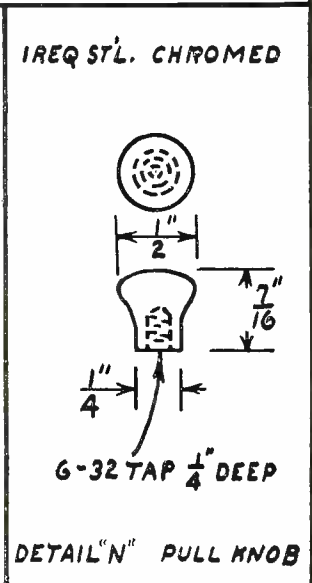
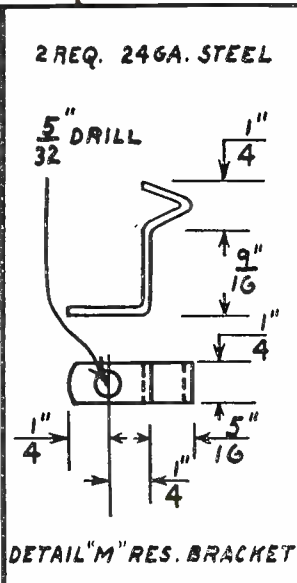
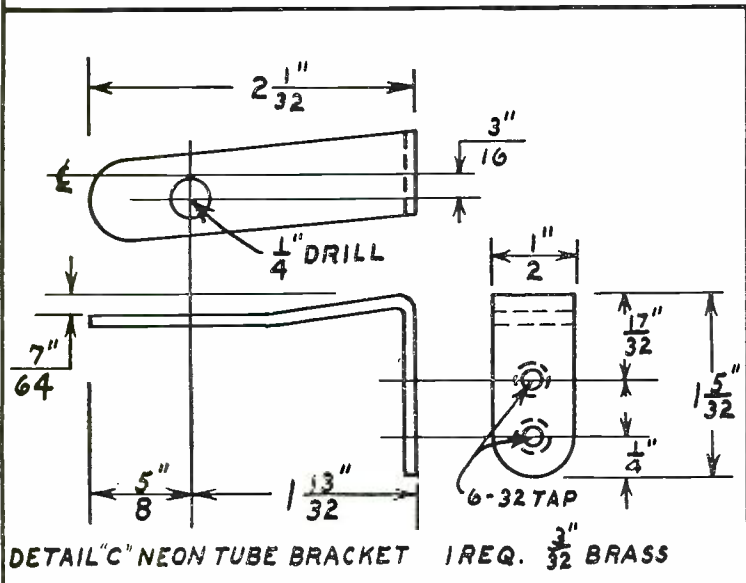
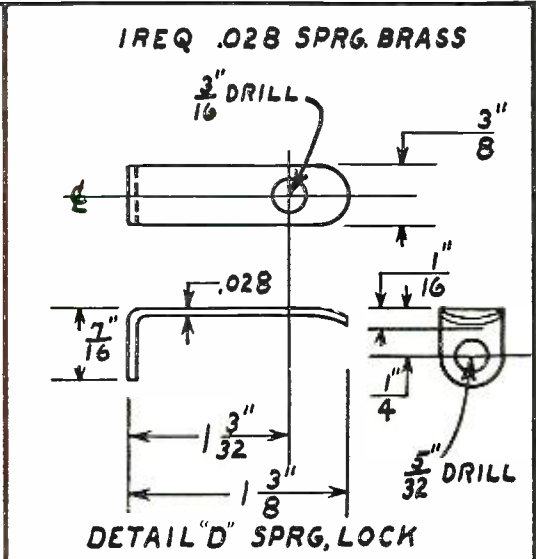
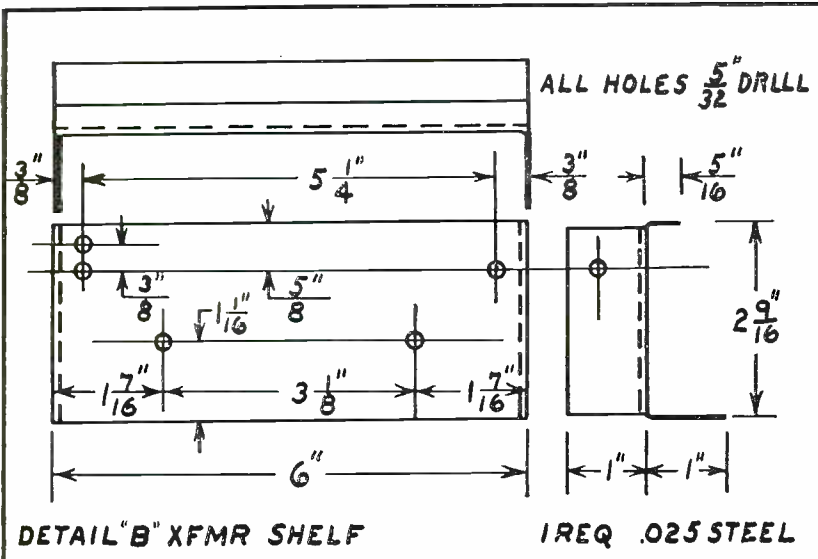

	A	B	C	D	E	F	G	H	J	MATERIAL	NO. REQ.
DETAIL E	1"	1"	$\frac{11}{16}$	$\frac{11}{16}$	$\frac{3}{8}$	NONE	.052	$\frac{5}{32}$		BRASS	1
.. F	1"	1"	$\frac{11}{16}$	$\frac{11}{16}$	$\frac{3}{8}$	$\frac{3}{8}$	.052	$\frac{5}{32}$		..	1
.. G	$\frac{13}{32}$	1"	$\frac{9}{32}$	$\frac{11}{16}$	$\frac{3}{8}$	NONE	.052	$\frac{5}{32}$		..	2
.. J	$\frac{7}{16}$	1"	NONE	$\frac{11}{16}$	$\frac{3}{8}$	..	.052	$\frac{5}{32}$		..	2
.. K	$\frac{15}{32}$	$\frac{3}{4}$	$\frac{9}{16}$	$\frac{1}{4}$	$\frac{3}{8}$	..	.035	$\frac{5}{32}$		STEEL	4
.. L	$\frac{1}{2}$	$\frac{7}{16}$	$\frac{1}{4}$	$\frac{5}{16}$	$\frac{3}{8}$	..	.035	$\frac{5}{32}$		..	2

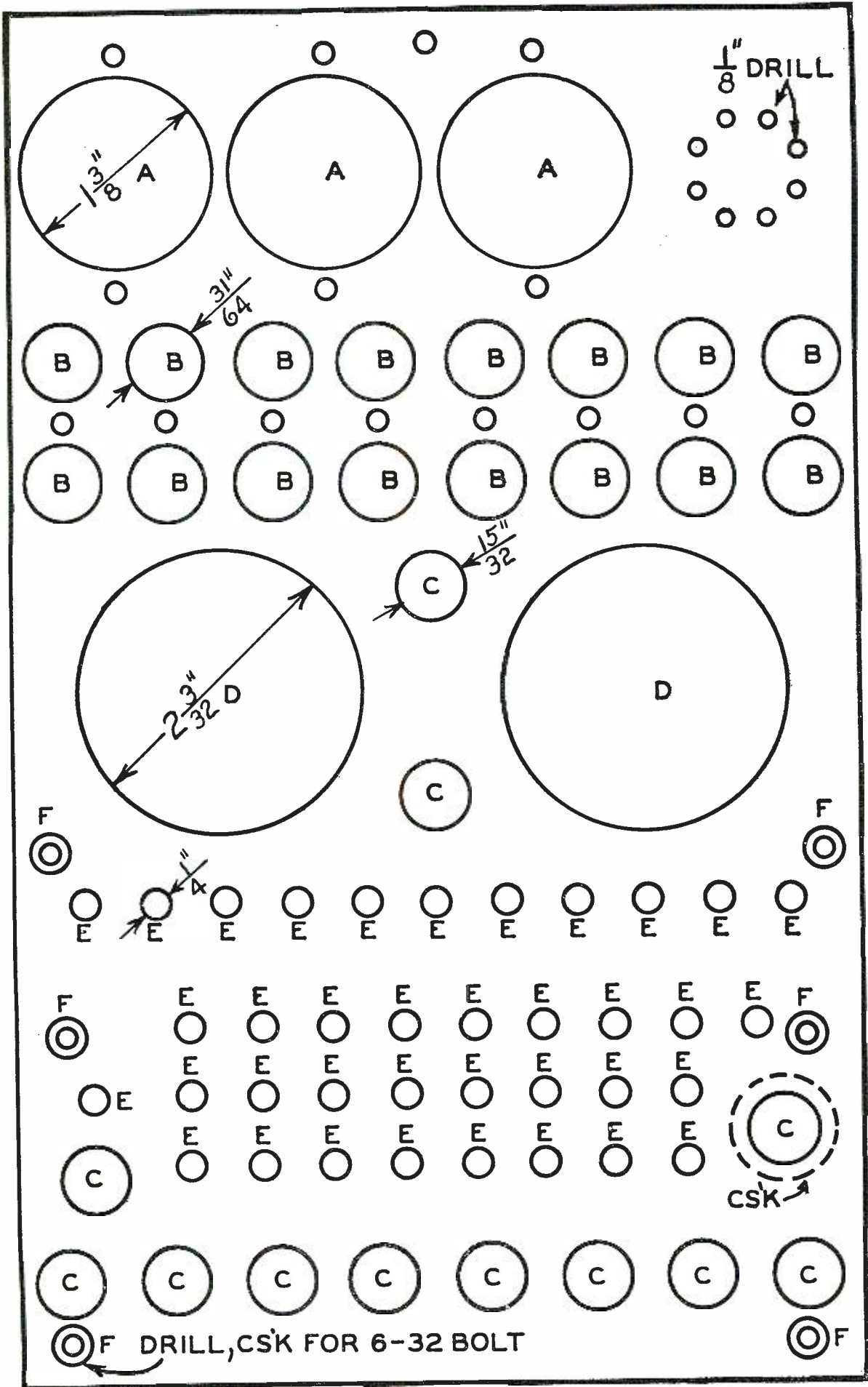

Full scale drawing of the Perpetual Analyzer-Tube Tester.



PARTS LIST

WIRING SYMBOL	PARTS	MAKE	Drawing Detail
	1 Sub-panel Socket, combination 4, 5 and 6 prong.....	(Naald)	
	1 Sub-panel Socket, combination 7 and 7 small.....	(Naald)	
	1 Sub-panel Socket, 8 prong octal.....	(Naald)	
	1 Plug, 8 prong octal.....	(Bud)	
	8 Molded Circuit Opening Twin Jacks.....	(Yaxley No. 432)	
	1 Male Cable Connector, 8 prong octal.....	(Amphenol PM8)	
	1 Female Cable Connector, 8 prong octal.....	(Amphenol PF8)	
	5 ft.—9 Wire Cable.....	(Consolidated)	
	2 Rubber Plug Handles for Cable Connectors.....	(Amphenol RPH)	
	2 Adapter Tops, 8 prong octal.....	(Bud)	
	3 Adapter Tops, 8 prong octal Sockets.....	(Amphenol RS8)	
	1 Adapter Bottom, 7 prong medium.....	(Bud)	
	1 Adapter Bottom, 7 prong Small tube base.....		
	1 Adapter Bottom, 6 prong Small Tube Base.....		
	1 Adapter Bottom, 5 prong Tube Base, small size.....		
	1 Adapter Bottom, 4 prong.....	(Bud)	
M1	1 Voltmeter 0-6 volts a. c.....	(Readrite Model 55 No. 353)	
M2	1 Milliammeter 0-5 ma. d. c.....	(Readrite Model 55 No. 305)	
	2 Meter Back Mountings.....	(Littlefuse No. 1059)	
F1	1 Meter Fuse ¼ amp.....	(Littlefuse)	
F2	1 Meter Fuse 1 amp.....	(Littlefuse)	
T1 & T2	2 Single Pole Double Throw Toggle Switches with neutral position.....	(Cutler-Hammer)	
R1 R2 R3	1 Wire Wound Resistance 2820 ohms 10 watts tapped at 84.6 ohms and 536 ohms (made from Polymet 500 ohm 10 watt resistor).....		
R4	1 Wire Wound Resistor 1.0367 ohms (made from 42 ft. 9 5/8 in. of No. 24 Copper Wire).....		
R5	1 Precision Resistance 50,000 ohms 5 watts.....	(Precision Res. Co.)	
R6	1 Precision Resistance 40,000 ohms 5 watts.....	(Precision Res. Co.)	
R7	1 Precision Resistance 7,500 ohms 5 watts.....	(Precision Res. Co.)	
R8	1 Precision Resistance 833.3 ohms 5 watts (Precision Resistance Co. 800 Ohms with 127 ft. 9 in. of No. 34 Copper Wire wound over it).....		
R9	1 Precision Resistance 333.8 ohms 5 watts (Precision Resistance Co. 200 ohm & 100 ohms with 129 ft. 5 1/2 in. of No. 34 Copper Wire wound over them).....		
R10	1 Precision Resistance 131.8 ohms 5 watts (Precision Resistance Co. 100 ohms with 121 ft. 1 1/2 in. of No. 34 Copper Wire wound over it).....		
S	8 Metal Plunger Push Button Switches—single pole double throw.....	(H. and H.)	
	1 Extractor Fuse Post.....	(Littlefuse Type 1075)	
F3	1 Fuse 2 amp. type 3AG.....		
R11	1 Resistance 500 ohms 10 watts.....	(Atlas)	
R12	1 Resistance 2250 ohms 2 watts.....	(I.R.C.)	
R13, R14	1 Line Cord Resistor 330 ohms.....	(Ohmitc)	
	1 Candelabra Socket (Part of foveled pilot light).....		
N	1 Neon Light ¼ watt, candelabra base.....	(G. E.)	
CI	1 Condenser .1 microfarad 600 volts.....	(Aerovox)	
F.T.	1 Filament Transformer.....	(Readrite Model 406)	
B	1 Dry Cell.....	(Eveready No. 935 Size C)	
	1 Hard Rubber Panel 7 in. x 9 in. x 3/16 in.....		
	1 Transformer Mounting Shelf.....		
	1 Neon Light Socket Bracket.....		
	1 Spring Lock for Top of Upper Panel.....		
	1 Bracket to Fasten Transformer Shelf to Lower Panel.....		
	1 Bracket to Fasten Transformer Shelf to Lower Panel.....		
	2 Brackets to Fasten Lower Panel to Case.....		
	2 Brackets to Fasten Upper Panel to Case.....		
	2 Brackets for Supporting Top and Upper Panel.....		
	4 Brackets for Mounting Precision Resistors on Sub-panel Sockets.....		
	2 Brackets for Mounting Precision Resistors on Circuit Opening Twin Jacks.....		
	2 Brackets for Mounting 2820 ohm Resistor on Sub-panel Sockets.....		
	1 Pull Button.....		
	1 Threaded Shaft 6-32 by 5 1/2 in. long.....		
	2 Threaded Shaft 6-32 by 4 in. long.....		
	2 Universal Clips.....	(Mueller No. 48B)	
	1 Alligator Clip.....	(Mueller No. 65)	
	1 Alligator Clip Insulator.....	(Mueller No. 87 Black)	
	1 Phone Needle Test Prod Red Handle.....		
	1 Phone Needle Test Prod Black Handle.....		
	20 Phone Tips.....		
	36 Phone Tip Jacks.....	(Yaxley 417)	

Detail A  
Detail B  
Detail C  
Detail D  
Detail E  
Detail F  
Detail G  
Detail H  
Detail J  
Detail K  
Detail L  
Detail M  
Detail N

are brought into the circuit by means of single-pole-double-throw toggle switches with a neutral off position. The spare lug on the a.c. switch may be used for another shunt.

The tube tester consists of a filament transformer, line cord resistor and short tester. The filament transformer was taken from the Readrite model 406 tube tester. The 6.3 volt winding was obtained by tapping the secondary winding at the proper point. The 330 ohm resistance takes care of the 12.6 volt heaters, while the tap at 290 ohms provides for the 25 volt heaters.

The only information necessary to test a tube is to have its socket connection diagram. To illustrate let us consider testing a type 27 tube. Referring to the diagram, using the old R.M.A. numbering system, we find that No. 1 is control grid, No. 2 is plate, No. 3 and No. 4 are heaters and No. 5 is cathode. The connections between the units are made as follows: No. 1 is connected to G, No. 2 is connected to M—, No. 3 is connected to 2.5, No. 4 and No. 5 are connected to C, and P is connected to the 12.5 volt tap on the milliammeter. The current through the milliammeter is noted, switch Q is pressed, and a new current is noted. These values are compared with values obtained by testing new tubes.

Tubes are tested for shorts by connecting all the prongs, except the heaters, to terminals marked S and pressing the corresponding switches S one at a time. A bright glow in the neon bulb indicates a short, a slight glow will be seen on good tubes. This can be overcome by connecting a resistance across the neon bulb, but this reduces the sensitivity of the "short" tester. Space does not permit listing all the tube connections and current values, but these can be obtained by checking tubes as indicated above.

The manufacturers of vacuum tubes have constantly improved tolerances in construction during the past several years and nearly any new type will serve as a standard by which others may be judged. It is possible that the constructor might be acquainted with a local serviceman, and if such is the case, the dealer stock may be used to obtain the various readings as it is not necessary to remove the new tubes from their cartons in order to make insertion into the sockets.

Most service instruments take a lot of punishment during the day's activity, and for this reason care must be taken to tie down all parts securely and to make good soldered connections. Other makes of meters may be used if desired, providing they possess the same internal resistance, otherwise the resistance values given will not hold in cases of other values.

Complete diagrams are given to help the constructor in the building of the tester and all details for special brackets are illustrated, together with a complete panel layout as used on the original model. —30—

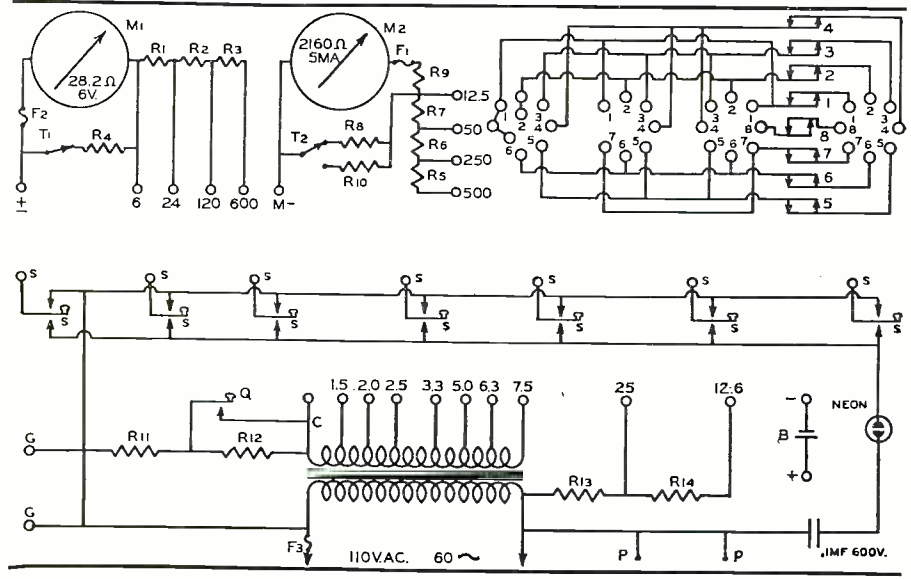

# AS I SEE IT!

By **JOHN F. RIDER**

Dean of the Servicemen

## A general discussion of the subject of tube discounts, and the operation of the shop to take care of the situation.

(The opinions expressed herein are solely those of the author, and do not necessarily represent those of the Publisher nor Editors of RADIO NEWS.)

THE antenna lead-in usually is the most insignificant part of a radio installation, but not in my house. Not that I asked for what happened, but it did and I've been catching—ever since. I'll tell you the story. It does have a moral.

I had two television aeriels installed upon my roof. Yes, they were installed by an organization who has an arrangement to install a number of different brands of television receivers here in New York City. I prefer having such work done by outsiders because it makes good copy—you know, how they work—what they charge—what the men say, and so on.

Well, this job was done to perfection. The roof was properly surveyed and the two antennae were spotted in the most advantageous positions. The antennae worked swell, one antenna for each television receiver. The job was finished just about dusk and Mrs. R was very much elated; so much so that we invited company for the evening. It was going to be a television party.

The crowd arrived and we watched a swell television program. After it was over the lights were flashed on and everybody blinked until their eyes became adjusted to the new light. (Perhaps it would have been better to have kept the crowd in total darkness.) Well, the lights were on and after the complimentary remarks had been passed, one person very sweetly asked, "Is that black wire necessary? It looks terrible against the wall." "What black wire?" asked the mother of Janet.

Gentle reader, that one question has not been explained away as yet. Ref-

erence was being made to the lead-in. Black on White. Jet black wire on nice cream colored moulding. Yes, sir, attached to the moulding. Now I know that the lead-in is not important, although in television work it must be fastened so that it does not move and that also applies to the portion coming down from the roof. But why *black wire*? The walls in the average apartment are not black. They are anything but black and to run such wire against a green, blue, cream or white colored moulding makes it stand out like a sore thumb.

There are going to be many television antennae installed in time to come and servicemen who do the work must convey to the manufacturers of lead-in wires that at least two colors are necessary, cream or white and brown, but not *black*.

Brown wire will blend with the usual floor coloring or with carpeting of various kinds, that is if it is run along the floor—whereas, cream or white usually will blend with the wall coloring if run along the moulding above the floor level.

Maybe the wire manufacturer has some reason why black is best for outdoor work, I don't know, but even if that were true, the wire inside the room should not be black. A splice in the wire just before it enters the window will do no harm. . . .

My wife is no different than other wives and she does not like black wires on a cream colored wall.

And now that I think of it, I don't like it either. Someday I'll change it.

### The Tube Problem

There are times when I wonder if the tube situation is not confused in the minds of many servicemen because they do not realize the significance of discounts. A 40% discount can mean just as much or just as little as 50 and 10, depending entirely upon the list price. "Up" the list price and the former discount is just as much in actual dollars as the latter discount with a lower list. But is it the actual discount that matters or is it the final amount in dollars with respect to the operating expense?

What does it cost a serviceman to sell a tube? That's the question.



John F. Rider

That, of course, depends upon how he operates. The man who makes his money on service does not require as much profit on tubes as the man who operates at a lower service charge and allocates a portion of his expense to sale of tubes. At the same time I appreciate that the lower the service charge, the greater the attraction to the customer, but there must be a happy compromise some place. Looking at the subject from the various angles which are associated with service activity, I seem to feel that with resale price regulations being what they are, the serviceman cannot hope to compete with chain store, department store, and other similar advertising. Neither has he the resources nor the method of approach.

What would happen if all servicemen in America stopped selling tubes. Not that this will ever happen, but just suppose that it did. Suppose that tube sales were such that service men could not sell tubes. They would have to cultivate such selling tactics as would provide the proper income from the other sources associated with the usual service shop activity.

Recognizing that tube troubles represent the predominant defects in radio receivers, is it possible that too much emphasis is being placed upon tube testing, free or otherwise. Maybe that argument is worn out because it is used too much. Maybe the industry must conceive of some other method of approach, wherein the tube is not the vital item, so that the profits from tube sales, while important, do not mean the difference between success and failure. And if such a condition exists today as far as tubes are concerned, why all the excitement among servicemen.

We know of servicemen who consider tubes secondary—who find it possible actually to compete with the chain or department store. Not that they sell for exactly the same price as these do, but they provide a profit for themselves, by knowing the true significance of the discounts, just how much it nets them—what proportion of cost of running the service shop can

(More As I See It on page 58)



Believe it or Rip, this is NOT an American service bench. It is located in Malines, Belgium. R. Vereack, Owner.



# 1940 Radio News "ALL PURPOSE" TRANSMITTER-RECEIVER

by **KARL A. KOPETZKY, W9QEA** and **OLIVER READ, W9ETI**  
 Managing Editor, RADIO NEWS      Technical Editor, RADIO NEWS

## Part Two

***In this section the heart of the unit—the exciter, speech and VOX system are fully described. They may be included in your station on existing rigs to increase the amateur's operating efficiency.***

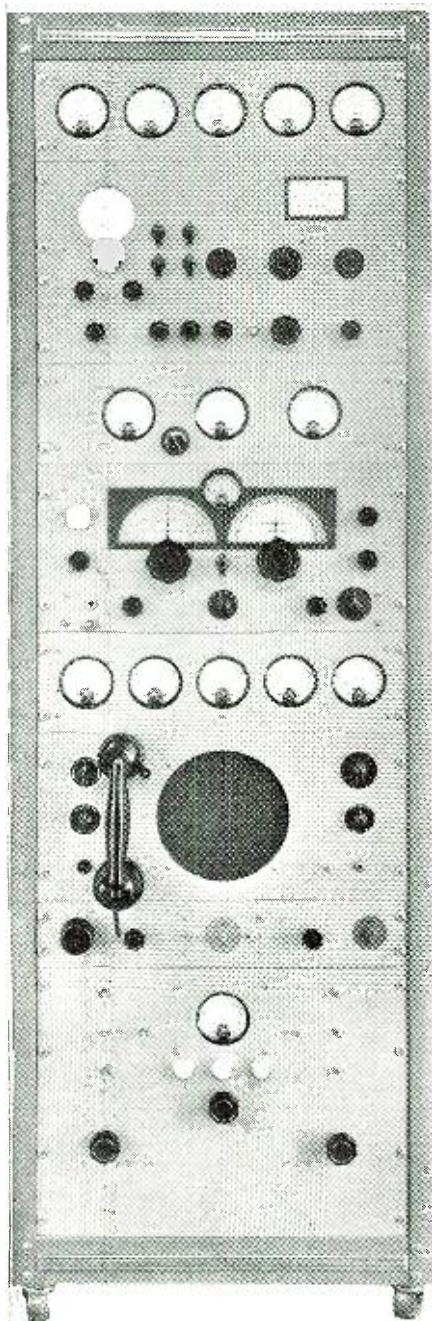

While the unit has a complicated appearance, it only requires the manual operation of two switches to transfer from "transmitting" to "receiving."

**T**HOSE who have seen the complete transmitter-receiver in operation have all been amazed at the simplicity in operation of the VOX system and the associated units. One cannot help being enthused about voice-control or automatic standby for cw after using these features. It is one thing to throw a series of switches when changing from the transmit to receive position, and another to be able to have the voice or key do the switching automatically for the operator.

Last month's article described the various power supplies used in the rig, together with general constructional data pertaining to several of the units. Now we come to the description of the speech amplifier, the RADIO NEWS VOX system and the exciter units.

### Speech Equipment

There are two possible types of amplifiers that we may use in a universal-type of transmitter. One is a standard speech system designed for operation from the 110 volt-60 cycle mains, and the other designed for either 110 volt a.c. or d.c. lines. In order to determine the one best suited for use in our transmitter, we built both types and gave each a complete test under actual operating conditions.

We stressed the importance of economy insofar as line consumption is concerned. The d.c. amplifier, being universal, is the most desirable type to use—providing we do *not* incorporate the VOX. Unfortunately, when used in conjunction with voiced-controlled circuits, we ran into difficulty from the d.c. 400 cycle commutator ripple that upset the VOX. This caused the latter to operate from the induced hum feeding into the 500 ohm line at times when it reached a certain level.

Condensers were installed in order to reduce the ripple but this upset the voice characteristics to such an extent that the quality was impaired. Accordingly, the standard a.c. type was

constructed and our troubles were over.

It should be noted that the 400 cycle note of the d.c. mains was only apparent in our speech amplifier-VOX because we made our own a.c. Had this not been so, and had we wished to stay on d.c. and not create a transmitter which would operate *equally well* on a.c., we could have solved the problem with filters, condensers and the like in the usual manner.

### The A.C. Amplifier

Any conventional type of speech amplifier may be used, but in order to cut down the primary drain as much as possible, this should be designed for a minimum number of tubes and stages. It is not necessary to use a push-pull arrangement in the output stage in order to obtain good quality on voice. A single type 6F6 offers ample output to drive the TZ40 modulators, is easily driven, and requires but 300 volts from its power supply. The total drain is on the order of 50 watts and is supplied from the 350 watt motor generator when the transmitter is being operated from a direct current line.

A 6J7 provides ample gain from a crystal mike and drives a single 6C5 triode. All control leads are shielded in order to prevent surrounding fields from inducing hum into the amplifier. The extended gain-control leads must also be shielded for the same reason. One of the nicest gadgets for the modern phone transmitter is the inclusion of a peak-compressor to limit the amount of the amplifier gain, regardless of the input voltage.

Reference to the schematic will show how such a circuit can be added to any single-ended audio amplifier. A type 6H6 twin rectifier is used to change the audio currents into d.c., and these rectified currents are fed into the suppressor grid of the 6J7 in the form of bias. The amount of bias applied to the suppressor will control the gain, within limits, to the 6J7. A

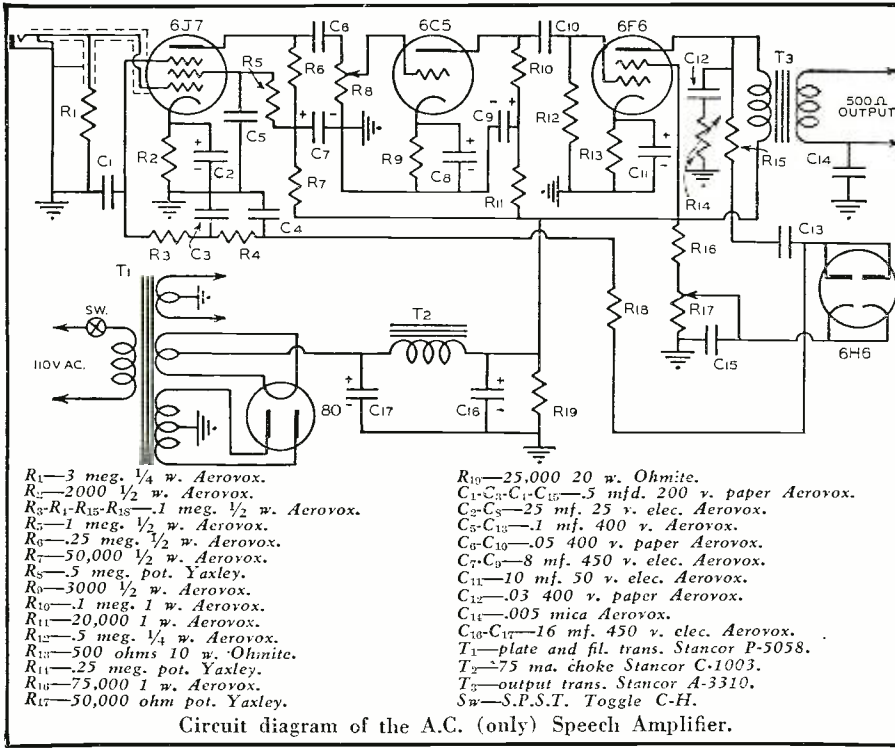

75,000 ohm potentiometer is used to regulate the amount of rectification at the 6H6 and, once set for a given microphone and amplifier, will need no further attention.

As the input tube we could have used a 6L7 with equal results in that it, too, possesses a suppressor by which the peak compressor action can be had. We found that this tube was of a higher gain, and that it was liable to be less stable in operation than the chosen 6J7. In manufacturing your own a.c., as we do in the case of the unit,

the frequency as well as the voltage is liable to shift between wide ranges and an extremely stable circuit will be found to be the only one which works satisfactorily.

The entire amplifier is built on a standard Bud 10 1/2"x5"x3" metal chassis. The unit is provided with an overall shield cover. This cover is perforated to allow proper ventilation to reach the tubes. It is important that sockets with good contacts be used as the tubes protrude out in a horizontal direction after being placed in the

cabinet. All of the tubes with the exception of the rectifier are of the heater type and it makes little difference in what position they are mounted.

The plate-to-line transformer is mounted on the top of the chassis, while the choke and filter condensers are mounted below. All by-pass condensers should be located and connected as near the individual lugs as possible to effectively by-pass the circuits. A common ground bus should also be used in addition to the chassis for effective shielding. In the a.c.-d.c. type, it is necessary to float the ground returns to a common lead after which the system is grounded to the chassis through an isolating condenser.

Brackets are fastened to the four corners of the chassis base to facilitate mounting within the cabinet. The mounting flanges can be tapped or hex nuts soldered to these brackets so that much effort will be spared the constructor when placing the unit into the cabinet.

Terminal lug strips are provided at the end of the chassis for making the connections to the associated circuits in the transmitter. The leads for the tone and gain controls are extended and brought down to the speaker panel where they will be accessible to the operator. These leads must be completely shielded, and the shielding grounded.

The line switch is also brought out to the panel and may be seen on the panel containing the three meters above the receiver. The completed speech amplifier mounts in between the receiver and the bottom shelf holding the exciter unit.

**The D.C. Amplifier**

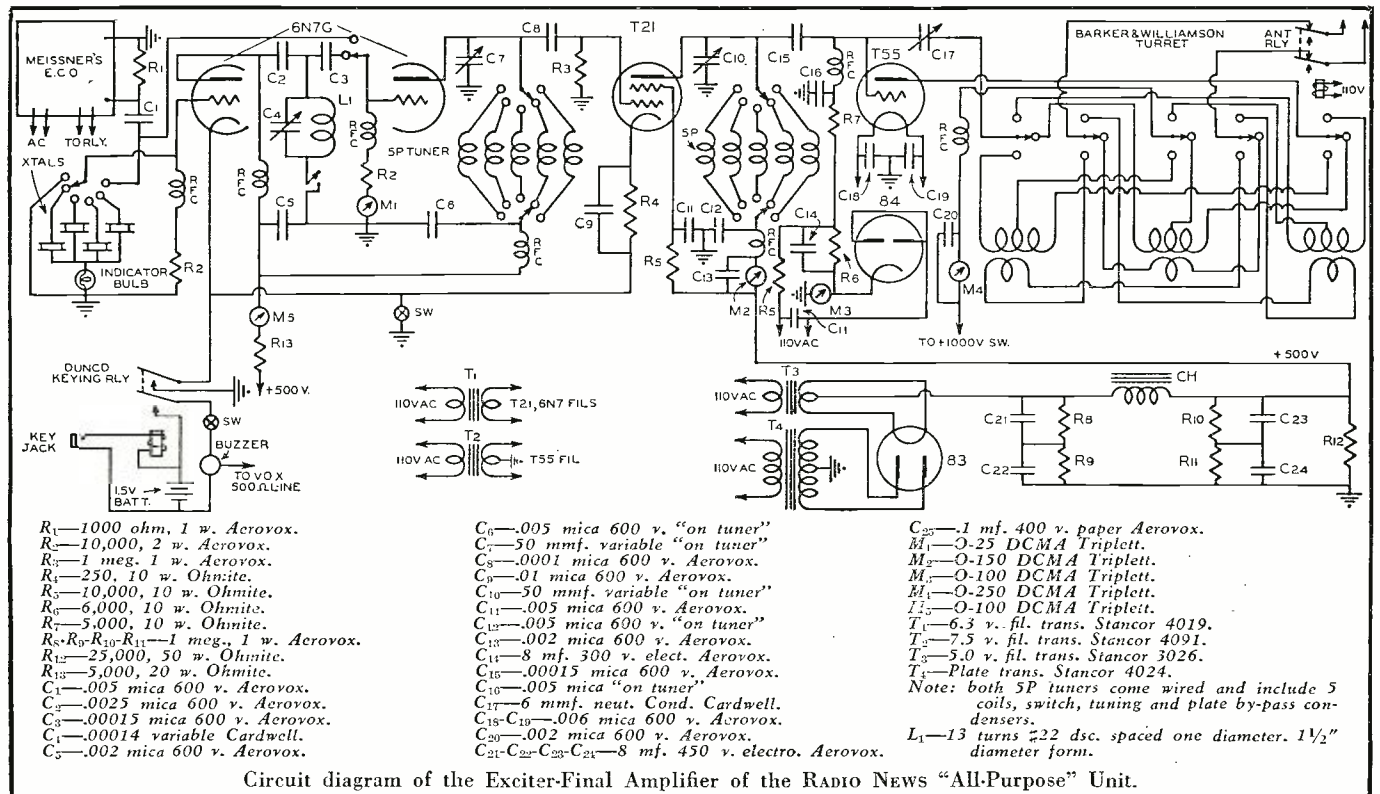







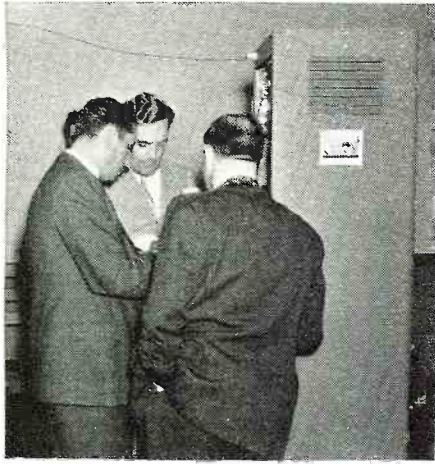

tem of voice-control has been used by the writers for many months with excellent success. Briefly, the VOX circuit is an amplifier that contains a series of vacuum tubes and a special relay. This relay (Guardian) is placed in the plate circuit of a '37 output triode so that any change in plate current within the tube will cause the relay to be energized and in turn, close the relay contacts for the external control of associated circuits. A type 885 gas-discharge tube is used as a bias-control device to the 37. The amount of control is set by the sensitivity potentiometer and the time-delay by resistors.

If audio is fed into the system, the voice or sound will be amplified and fed to the control tube, through the 885 and thence to the 37 in the output, where the relay will be opened. The length of time these contacts will remain opened is set by the selector switch. We may have the relay operate in a fraction of a second or longer at option.

**Automatic Keying Standby**

The above VOX system works to perfection as a means of turning the power on and off during periods of transmission. Suppose we set the delay to three seconds; upon concluding a transmission the transmitter automatically goes off and the receiver is placed in operation exactly three seconds following the last dot or dash. The time delay may be used by either the speed artist or the lid by making the proper setting.

A Federal high-frequency buzzer is connected to the 500 ohm line. The audio note from the buzzer acts in the same manner upon the VOX as does (Pse QSY to page 60)

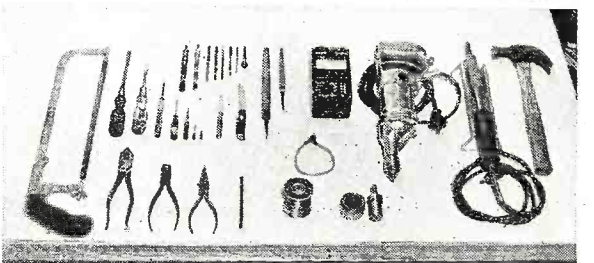
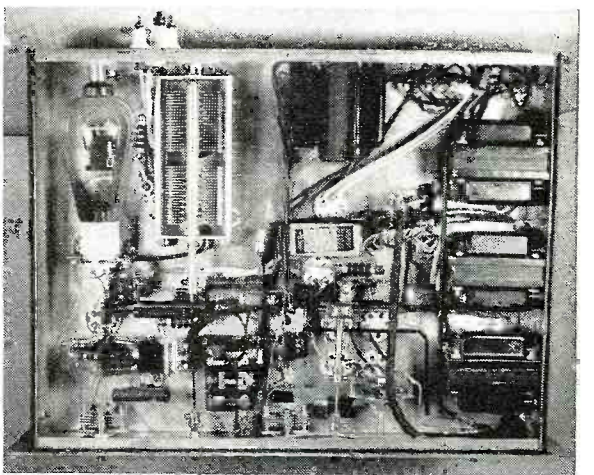
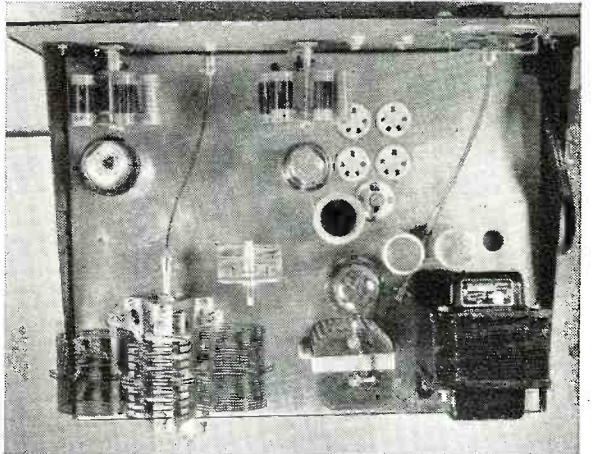
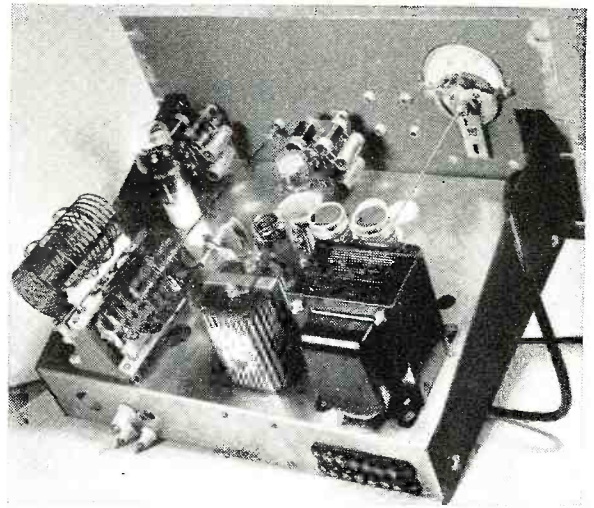

The column at the left shows how well the trade turned out for the preview of the RADIO NEWS "ALL-PURPOSE" Transmitter-Receiver. The top three illustrations of the right column show the exciter-final RF amplifier chassis. The sockets are for xtals and the 80 meter coil, which also is used on 40 meters in the xtal tank circuit. Crystals are remotely tuned from the panel with flexible shafting and insulated National couplings. The bottom illustration shows all the tools used in the construction.





by **LEE WARD**

Service Manager, San Francisco, California

Welcome

Dear Mr. Ward:

Enclosed is a picture of my service shop at home. . . . As I am just beginning in the radio business, after experimenting for two years, I haven't too much professional servicing equipment. I am 19 years old and a graduate of \_\_\_\_\_ . My shop



is twelve feet square. I made the table myself. I have made a photoelectric device completely, and it is very efficient. I have a well-lighted room and plenty of storage space, which, together with equipment are I think the essentials of good servicing. I hope . . .

Gilbert Wayne.

I'll do what I can to help you, Gil. Let's see what you have to start with: Telephone fuse mounting, rural type. Three watt-hour meters. Telegraph company call-box. (The utilities seem to be well-represented!) What are those glass things on the corners of your filing cabinet? Cross-arm insulators! I hope you didn't have to chop down the poles to get them, Gil. I wouldn't have taken the "KEEP HAND'S OFF" sign; that's adding insult—and besides, it has a misplaced apostrophe. In the future, the picture of the two hunting dogs—while it might now serve to symbolize the taint you will use in going after repair jobs—had better be replaced by a list of customers who have forgotten you for more than a year. That tilted instrument looks pro, but the two doorbell push-buttons don't. You'll soon learn other persons' push-buttons are more important than your own.

That's a nice stunt you have of mounting the soldering-iron rack about 45 degrees from horizontal—heats up more quickly as the hot air from the barrel passes up around the tip. I notice the fan is mounted so as to blow on the telephone instrument. You'll need it there sometime in the future—perhaps just after you have sold a new set of tubes to a set

owner who wants to be sure to hear a world series game. You will destroy his old ones with a great display of honesty, only to learn, upon return to the shop, that one of your new tubes went west as soon as you left his house. He will call you on the phone to express various opinions regarding the profession; you will tell him you will be right over with a new one; but will find out after you hang up that you have no more in stock. The fan, as I said, will come in handily blowing over the telephone. Thereafter, you will make it a point to explain to tube customers they should have an extra tube of each type on hand to guard against such emergencies.

If any old-timer smiles at the equipment you have on your test bench, do not take offense; he smiles only because he remembers his own first collection. The unnecessary items will weed themselves out without planning. Your test bench shows you are like most other beginners; that you were brought into the trade with an inclination toward the technical side of the profession. Many of us have made the mistake of stressing the scientific side of the business at the expense of the practical side; of attaching more importance to a "photoelectric device" than to the well-pressed clothing your other photo shows. Unfortunately, the connection between pure science and filthy lucre is remote. In the servicing game, your good appearance will be a two-base hit; the "photoelectric device" nothing but a pop fly.

The bias toward the technical side works against a serviceman after he gets into business. Before that, he gets a great satisfaction from freelance gadgetry; afterward, his income depends upon his business acumen. If all beginners would declare a technical moratorium for two months, devoting the period to a study of business management instead of circuit diagrams, better balanced characters would result. Too many of us—even the old-timers—know our meters better than our customers. Keep in mind that, no matter how intriguing a new schematic may be, not one of them ever reached down into its pocket and paid for the attention you gave it!

After you've been in the business for many years, there will be dull stretches during which you will wonder why you ever got started. These

will be followed by periods so profitable you will wonder how long such windfalls have been dropping. During these cycles, don't let either phase you.

Eventually your education, field training, business acumen and the knowledge of the peculiar conditions in your store location will enlarge to form a very practical background, and your activities will be characterized by *savvy*. This quality pays off well in *any* profession—but its components are too complex to derive from any one source. The time has come, then, for me to fold up my crystal ball.

Come what may—I welcome you into the field. I wish you luck and hope your transformer jobs always outnumber your "intermittents"!

#### No Competition

Notice has come from one of the city's largest distributors to inform of a change in policy. The most interesting points:

Parts and tubes within the guarantee period will be checked and replaced free of charge; but no free service work will be done on sets, even though they are within the guarantee period.

Service work will not be accepted directly from the set owner. The customer must do business through the dealer or serviceman. If the dealer requests that the distributor's man work in the customer's home, or in the retail store, such work will be done only in the presence of the serviceman. The minimum charge (for the first hour or fraction) is three dollars.

Seems as though we who charge too little for fear of losing trade will be assisted into a better price level by these regulations. That \$3 minimum, remember, is a *wholesale* time rate, and—if we call a distributor's man in on the job, we are entitled to make a higher charge to the customer. We will be protected in this charge by the distributor's refusal to accept service work directly from the set owner. Means the distributor is not in competition with us—which is as it should be.

#### Similar Symptom

Servicemen located near water get so accustomed to warped *Temple* speaker cones that they usually presume all raspy-tone complaints are  
(*More Notes on page 56*)

# SOLUTIONS

UPON answering a call, you enter a living-room. Several members of the family are listening to a radio program. The set sounds disappointingly normal; and when you ask what the trouble is, the owner smiles and replies: "Nothing, just now—but sit down and wait!" It is the dread enigma of all servicing—an "intermittent"!

Two commercials later, you stir un- easily and the set owner, by way of apology, says: "It *usually* fades after it runs this long. I can't understand what's wrong with it tonight. Perhaps you scared it!" His laugh does not improve your business, so you tactfully get in back of the console, hoping the trouble is not some condition which will remedy itself when you shove the cabinet away from the wall. At the same time, you also hope it will be one which can be located easily if and when you get the chassis into the shop. You poke the tubes experimentally, but the volume does not drop.

When you try to stall for time by unfolding your tube checker, the customer remarks: "It's not the tubes—this is the third set of them we've bought this year." You refold the instrument and—without turning off the juice—unbolt the tuning chassis. You lay it upside-down on a foot stool, remove the bottom cover, and observe new parts which show other servicemen have been called before you—and failed, just as you probably will, too!

Your audience is silent during your weird routine, for other actors have given the same performance before you. Despite the fact the set is still playing with a volume as unchanged as a hill-billy's shirt, you can sense their cynicism. To cover your confusion, you poke each component deliberately—not because you expect to be lucky enough to make anything become apparent, but because it gives you time to consider how to wangle a pay job out of the phlegmatic chassis. It also gives you time to wonder how—after going into the radio business to *repair* sets—you ever got into a spot where you are stumped because you can't break one down!

In desperation, you announce that the set must go to the shop for a more detailed analysis (meaning you are stalling for time) and that you will phone the customer (you hope) after the set fades (if ever) and give a price on the (probable) repair.

The customer is not surprised. He lets you take out the set more because he presumes on the law of averages than because he has any confidence in you as a talented professional. You have, after all, done nothing to impress him favorably.

You hook the set up in the shop, and a period of enslavement follows. It must play continuously, and the noise distracts from your simplest duties. The sun goes up, the sun goes

down; people go to work, they come home—but the volume level shifts less than the bottom of the Sphinx.

The customer calls you occasionally; not to learn if the set is fixed, but to make sure you are still in business. His set interferes with the conversation. Finally—to forestall insanity—you decide the cause of the fade has been an expensive filter block (because it contains the most parts under stress of high voltage) and you agree upon a price. When you have made the replacement, the pre-delivery test music is no longer a haunting, ever-present accusation of failure: it is a symbol of success, for you have met the problem and conquered it!

You install the set happily, and even stoop to pat the dog while you wait for the money. The dog has been patted before, and turns away. You receipt the bill carefully and explain the terms of the guarantee, and you leave the house a free, prosperous business man, lolling in good-will. You open the door of your car in high spirits. A window opens. The customer's head appears. It also opens. *The set has faded!*

You return sadly, realizing that—no matter what you do now—the customer will never again trust you. As you enter the room, the irate owner slams the window closed, and the set jumps up to normal volume. You install—after the customer's bitter suggestion—a 4c lead-in strip, which cures the trouble forever.

As you leave the house this time, the dog snaps at you. When you arrive at the shop, you tear up your diploma and swear to go back to work in the old man's delicatessen.

No one feature of servicing brings out the good or bad qualities of a repairman more than his treatment of "intermittents." His methods invariably distinguish him either as a *mechanic* or a *technician*. Unconquered, *fleeting fades* cost the serviceman more in time, money, and reputation than any other factor in his business. When he learns how to locate and eliminate them, his customers come back confidently for all subsequent radio work. It pays to know how to cope with "intermittents"!

**Of all the problems that the serviceman has to face, the most annoying and difficult is that of the "intermittent." This series will go into the reasons and solution of this most trying and expensive problem.**

Because of the varied natures of their evidences, *intermittents* are difficult to define. A *fade* is not necessarily an *intermittent*; the former may be caused in the receiver, the transmitter, or may be due to sky wave interference or other propagation phenomena, while the latter invariably is a fault to be found somewhere beneath the receiving antenna.

At first thought, it would seem that an *intermittent* is a *fade* which causes an instantaneous rise or fall in volume, but this is not so; an *intermittent* might fade slowly and come back abruptly upon electrical surge (such as that from a light switch), or it might fade abruptly and come back slowly. The customer calls all changes in volume "fades"; but within the trade, a *fade* is applied to slow rises or falls in volume; usually the ones which are easily located. If these rises and falls are repeated, the condition may be described as *intermittent*—without departing from the dictionary definition—but, in professional parlance, an *intermittent* does not become a problem worthy of the name until after the routine checks for *fade* have failed. Difficulty, more than repetition, plays a part in *intermittents*. A *fade* which cuts speaker volume permanently is a *breakdown* which yields to ordinary replacement procedure; even though the work during replacement is difficult, and the fault one which might have been temporary, but not called an *intermittent* unless there has been trouble in *locating* it.

An "intermittent," then, is any undesired, difficult-to-find change affecting the performance of the set.

The *causes* of most "intermittents" are simple, and the necessary *remedies* are usually made with ease. Thus, neglect on the part of the serviceman can (and has!) turned as simple a matter as a rubbing antenna wire into a tough case of "intermittent" reception. There seems to be a common agreement among us never to look at the simpler causes first—probably because we feel they are beneath our dignity. This, in a way, is fortunate; for the serviceman who will learn how to tackle trouble of this nature logically will eliminate half his "intermit-



# INTERMITTENT

by "TESTER" BRADLEY

tents" by common sense rather than by the use of elaborate test equipment. "Intermittents" do not exist *unless they are unseen*; the repairman therefore has it in his power to cut his *mysterious* work in half if he calls a *fade a fade*, and locates it before it passes into the more troublesome category.

My experiences in the field indicate that most servicemen have a tendency to become too technical when they tackle an "intermittent." They notice one unusual symptom, fly off at a tangent, and end up—three hours later—deep in an abstruse reference on Mutual Proximity instead of following logical steps which would lead them directly to the cause of the trouble—which is, as likely as not, a piece of solder between a socket lug and ground. There are tough ones, of course—but we manage to get ourselves into a bunch of grief simply because we can't see over a slide-rule.

So do not be surprised if some of the causes of "intermittents" in the following list seem those which should be obvious. The list has been prepared from actual work in the field, and gives the *reasons* for "intermittents" which were troublesome—not possible causes. Such a list would be infinitely long, since there are perhaps a hundred or more possibilities in every set ever manufactured. The list below shows how simple causes may lead to trouble, and is useful for review when a tough chassis gets you into a mental stalemate. When you get a tough one, and think you have examined every part, and analyzed every circuit point, run over this list to see if you haven't forgotten some angle of attack. It's worked more than once for me:

## Antenna Circuit

- Corroded joint between lead-in and antenna.
- Poor contact at rivets in lead-in strip.
- Motion and poor contact between wire and clip on lead-in strip.
- Faulty contact between ground clamp and ground.
- Antenna lead shorted to chassis.
- Antenna rubbing against conductive or semi-conductive material.

## Oscillator Circuit

- Tube checks O.K. but does not oscillate.
- Tuning condenser plates flake and partially short.

Electrical breakdown in tracking condenser mica.

## Power Supply

- Faulty contacts under cover of filter condenser.
- Improper contact between slider and voltage divider.
- Broken turn on divider, not apparent before breakdown.
- Current "creeping" between two divider taps.
- High resistance contact in off-on switch.

## Speaker

- Poor connection at voice coil lead rivet.
- Lateral scratch across voice coil winding.
- Voice coil which opened when critical cone excursion was exceeded.

## Power Line

- Burning contact at fuse block.
- Leak between transformer winding and core.
- Fused outlet contacts.

## Volume Control

- Loose terminal wire at inside lug.
- Dirt and wear under slider arm.
- Loose wire in resistance element.

## Tubes

- Faulty weld at element support; affected by heat.
- Inter-element short.
- Cold joint between wire and prong.
- Twisted glass envelop; shorted leads.
- Emissive coating drops between elements after flaking.
- Improper socket contact to prong.
- Heater-to-cathode buckle.

## Bypasses

- Open at inside connection.
- Short at inside connection—faulty finishing.
- Leak between elements and grounded cover.

## Resistors

- Cracked carbon rod.
- Loose terminal connection.
- Contact with other set parts.
- In wire-wound type, "creeping" between turns.
- Overheating from overload.

## Tuning Condensers

- Rubbing or dirty plates.
- Poor connection between rotor and chassis.
- Rotor "wipers" ridged at certain points.



Peeling plate made high resistance connection to ground.

## A-F Transformers

- Inter-winding leak.
- Imperfect insulation between winding and core.
- Lead riveted but not soldered.

## R-F Transformers

- Poor, but rigid, connection between can and mounting.
- Cold-soldered joint at lug.
- Cross-wire: winding to form.

One of the simplest faults is found in the type of circuit shown in the diagram. Many of the older sets—which means worn parts—still use the volume control circuit in this manner. If there is any suspicion of "intermittent" operation in any set of this connection, throwing out the volume control should be the first step of analysis. It will be seen that any short, wear, dirt, or open between points A and B will result in a shifting of the receiver's efficiency; and also that any wear, dirt, or open at C will produce a like result. The fact that the moving part is at the point of lowest signal level makes it an especially difficult component to check, and good practice is to eliminate the most probable source first rather than to waste too much time checking everything else. The control is probably so old

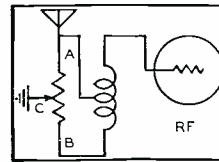

(Continued on page 46)



The unit is compact, and can be strapped to the steering post.

# Tube Auto-Radio J. H. F. Converter

by **McMURDO SILVER**

Engineer, E. I. Guthman & Co.  
Chicago, Illinois

**With this one tube converter and the usual auto broadcast receiver, an efficient 5-10 meter receiver can be made. Excellent for the mobile rig.**

THE increasing interest among amateurs in the possibilities of mobile operation in the 5 and 10 meter bands has created a definite need for well-engineered transmitting and receiving equipment for use in these bands.

Consideration of possible approaches to the designing of a satisfactory 5-10 meter mobile receiver are more involved than those applying to a mobile transmitter simply because there are at least two angles of approach. The first would involve the design of a complete mobile 5-10 meter super-heterodyne receiver, while the second utilizes an existing automobile broadcast receiver as the i.f.-a.f.-power unit of the desired receiver, which is then obtained by the addition of a 5-10 meter oscillator-first detector tuning unit which may be switched in or out at will. Examination of both of these possibilities point to the second as being by far the most desirable, for in building a special complete mobile receiver the cost of its i.f.-a.f.-power circuits would considerably exceed the cost of one of the better auto broadcast receivers, which by virtue of

large quantity production are most reasonably priced. The cost of the combination of auto set already owned by the majority of amateurs, plus the 5-10 meter converter may be kept quite low, with installation quite simple, motor noise something that hardly need be given a thought, and most important, no female member of the family may logically complain on any score since regular broadcast reception is in no way interfered with, except when the 5-10 meter tuner is in actual use. Again, this solution of the problem is a boon to those amateurs still operating receivers not covering the 5 and 10 meter bands, for it is no task at all to pull out the chassis of the unit here illustrated, hook it up to the regular station receiver and get excellent results on these bands—two uses all from the same little converter.

The 5-10 converter illustrated is exactly 6" long, 4" high and 4½" deep, and so may fasten to steering-post (with adjustable rubber-cushioned mounting plate and clamps), or can be fastened to the lower flange of a dashboard or even slipped into a glove

compartment if preferred. The panel is fastened into the grey enameled steel cabinet with thumb-nuts so as to be easily removable. At lower left it carries the tuning knob, which through a smooth 6 to 1 vernier reduction, drives the two-gang tuning condenser without the "slop" of the usual dial cable—something unsuitable for high-frequency receiver tuning. This vernier drive also desirably acts as a brake, so that once a station is tuned in vibration customary in a moving automobile will not shift tuning even on crystal-controlled 5 meter signals. The tuning dial is graduated 0-100 degrees. Through use of very low values of tuning condenser gang sections, and a layout resulting in very short tuned-circuit leads and negligible capacity, quite wide band-spread is obtained. The 5 meter band is spread out over 4" of dial scale, while the 10 meter band occupies 1¾".

Since the regular broadcast set in the car has volume and tone controls, there is no point in duplicating them in the converter. So it has only two additional knobs, one for selecting 5 or 10 meter operation, and one to cut the converter out of circuit. Incidentally, for extremely fine tuning the regular tuning knob of the auto set can be used. This in effect varies the intermediate frequency over a small range, and provides a very nice vernier.

Installation requires connection of the regular—or a special 5 meter—car antenna to one plug of the converter with shielded wire, connection of a second converter output plug through a second shielded wire to the car radio antenna plug, and three leads for A and B supply from the car radio to the converter. Using only 10 ma. from the vibrator B supply unit of the car radio, it will not overload any good vibrator unit, while the .3 amps. at 6 volts required for the converter tube heater can be forgotten about so far as its effect as extra drain on the car battery goes.

Examination of the diagram indicates that this converter is a first de-  
(Pse QSY to page 51)

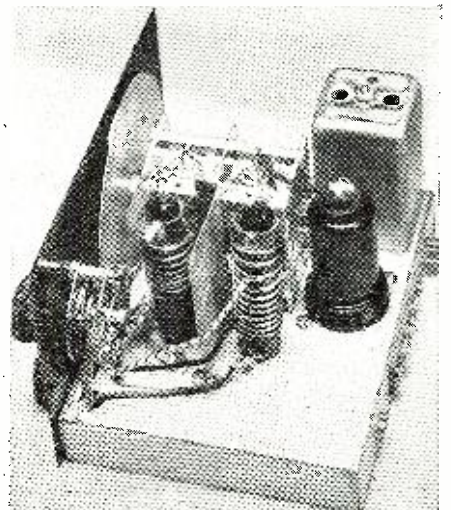

Short leads and simplicity mark the construction of the u.h.f. converter.



# Serviceman's Experiences

by LEE SHELDON

Chicago, Illinois

**What sort of charity job should be avoided, and which kind can be accepted? An interesting solution to the problem.**

BEAT Al into the shop because I got off early the night before. Usually there is an unanswered call or two on the blotter after my mid-week sabbatical, but there were none this morning. Because of this discovery—and a heavy breakfast—I sat down at the desk and was quickly lulled into a moody abstraction by the silence which attends my partner's absence.

When he came in he was humming, and I knew before he hove into view that it was one of his peppy mornings. His big days always follow my big nights, and I have come to hate the forced-draft days which he begins by clapping and wringing his hands.

"Now is the time for all good men to come to," he announced as soon as he saw I was resting.

"Please do not antagonize my mood," I said, "things are bad enough without having a phoney Pollyanna to contend with."

"Whazza matter," he asked, pouting and chucking me under the chin, "did my little fixer bruise his fimmer on a nassy ol' power pack?"

The worm turned, sharply. I hit his arm down. Nothing like that had ever happened before. We both looked surprised for a while, and then Al said:

"I ought to kick you out of the store. If I did that, though, you couldn't think for a week—and I need you in the business. What's the matter with you—is that stuffing in your shirt straining at the leash again?"

"I'm fed up," I said bitterly. "Our business association has been continually marked by your coarse manner, mental cruelty, and overbearing dictatorship. You cross me at every turn and hamper the exercise of my abundant talent. It's always *your* opinion that establishes the working policy of the store."

"I think you're letting your nerves get the best of you," Al replied, "and if you have any idea that your presence is pleasant during dull times, let me tell you how *I* feel. I've been taking aspirin secretly ever since we started in business together. About this 'coarse manner' business—can you tell me of one instance when I let my personal feelings take precedence over our commercial welfare?"

"Well," I replied, taken aback by his willingness to speak to me as an equal, "yes—how about yesterday, when that poor little fellow came in for a tube, but didn't have enough money to pay the full list price? 'A 42 costs \$1.25, to you and to everyone else,' you told him—even after he ex-

plained he wanted it to fix a Majestic his sick mother listened to all day!"

My partner looked upward at nothing, hit his forehead with his palm, and pulled his hand down over his face. "Some day," Al said, "I'll tell you all about that rounder. He is a professional recipient of alms who probably drew more salary than you did last week. But go ahead—what's your point?"

"It's just that you turned the fellow down without even asking me my opinion. It hurt me terribly to think that you refused to bring music back



"Turn it off! We'll be drowned!"

into a sad home at a cost of less than six bits!"

"You mean I should have given him the tube at any price he mentioned?" Al asked.

"Or free." I declared. "Everyone in business does a certain amount of charity work. The dentist goes to a free clinic on Thursday afternoons; the butcher tosses in an extra piece of meat when he knows a customer's family is down and out—did you ever hear of a fan dancer stopping to pass the hat after she walked over a subway grating?"

"Ah, my delicate little flower," my partner replied, falling back into his more natural manner, "do not wilt at one apparent brutality. Next time it happens, I'll promise to call a meeting of the board of directors when a customer tries to make up his own rules. I'll simply request him to wait at the counter for a day or two while we reach a decision. Is that what you want?"

"No," I said, "but the operating policy of *Salutary Sales & Service* should be determined only after deliberation following test cases in the field, rather than by one personal opinion. I be-

lieve we should do a certain amount of charity work, and I feel we should prove or disprove my contention by actually taking in a few free repairs for trial."

"As if the business wasn't already cluttered up with too many *unintentional* charity jobs!" Al shouted. "Charity should be confined to the off hours; while we're in the store, we should try to make money!"

"There you go again," I said, "making up rules for both of us without giving the idea a fair trial!"

"Okay, okay," Al said, relaxing in defeat. "We'll each pick up one charity job and report the results to each other. If the spiritual satisfaction justifies the work, we'll write it into the rules."

"Fine!" I said, "—and to keep it on a strictly charitable basis, each of us will pay for his job out of his own pocket—at net prices, of course. We will choose only someone who couldn't have the work done unless one of us paid for it."

"Suits me," Al said. "Just one thing more: since each of us is to work out of the other's sight, be sure your prejudice plays no part in your report. If you come in here lyin', you'll go out like a lamp!"

Wonder of wonders! Al came in the very next day with a Columbia, announced it was his test job, and went to work on it. Complete new set of tubes—new speaker cone—four resistors to take the place of some charred ones—thorough cleaning, and a painstaking alignment. After he put it on test, he figured up the bill, filed it, and put \$7.16 in the till! My, but I was proud of him! Perhaps I had misjudged my partner's finer instincts, after all!

My free job came two days later, when I was pulling a Radiola combination. The bolts were balky, and I had to go into the basement of a big apartment house to see if I could borrow a wrench from the 'super.' A perspiring woman answered the door. I looked about when she went off for the wrench; the rooms were very small, and appeared more squalid than they really were by contrast with the airy flats above. Three thin children with torn clothing dropped their jaws at me when they noticed my attention, and I turned away in embarrassment just as the woman returned.

I thanked her, finished my work upstairs, and brought the tool back.

"That radio," I said, pointing to a Kolster 7-A and 6-H speaker chassis,

(More Experiences on page 51)

# 5-20 M. X. M.

## Novel Design

by **FRANK C. JONES, W6AJF**

Berkeley, California

*The automatic modulation control which is featured in this u.h.f. transmitter is so constructed that it can be added to your own rig now. It will not disturb the speech.*

THE radiophone transmitter illustrated in the accompanying illustrations was built by the author for service on the five meter band at W6USA in the *Golden Gate International Exposition* on Treasure Island in San Francisco Bay. In order to make the transmitter have more interest to amateurs in general, it was designed also to operate in the amateur 10 and 20 meter bands. The complete set is entirely enclosed in a steel cabinet less than 3' high and is provided with a safety interlock switch on the rear door of the cabinet. This precaution was to prevent accidental contacts to any high voltage points which might be fatal to careless or curious operators.

The transmitter is plate modulated and has a novel form of AMC (automatic modulation control), which can be applied to nearly any existing phone transmitter. The novel feature is in the method of obtaining *advance* bias for the AMC rectifier tube in order to not disturb the speech amplifier circuit in any way except to connect to the suppressor or injector grid of the first amplifier tube.

A 6J7 pentode tube is shown in the

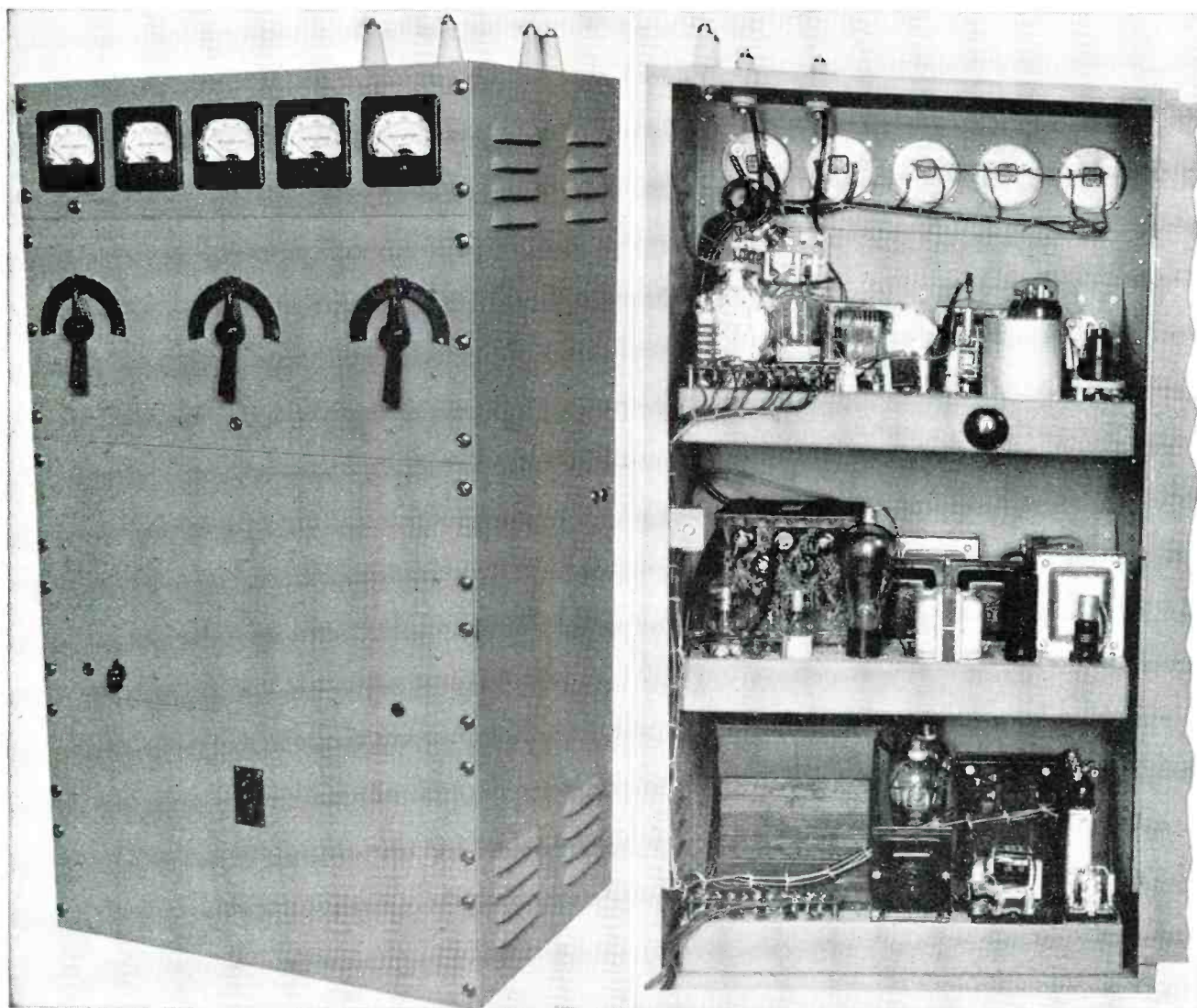

Note the very commercial type of assembly and construction. The rig is easy to build.





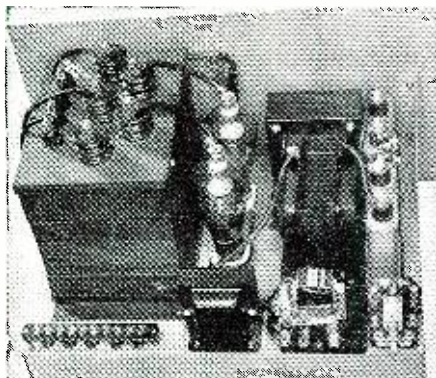

Power supply on left; modulators-speech amplifier on right.

than the individual audio frequencies. Negative bias to the suppressor injection grid of a 6J7 or 6L7 reduces the amplification of that stage during the time that this bias is greater than zero in a negative direction.

The 6J7 drives a 6L6 or 6V6 tetrode class B driver stage. Inverse feedback in the 6L6 reduces the plate impedance and provides a good class B driver having more gain than a low mu triode driver stage. The circuit shown is suitable for speech operation with very good quality. The 6L6 drives a pair of HK 24 gammatron tubes in class B to an output of 100 watts.

The radio frequency portion of the transmitter is so designed that only two coils need be changed when tuning to 5, 10 or 20 meters. The whole r.f. unit is mounted on one chassis 13" x 17" x 2", and requires only three dial controls. A 6C5 Pierce untuned crystal oscillator employs 80 meter crystals for 5, 10, or 20 meter band output. The 6C5 triode drives a 6V6G doubler which is tuned to 40 meters by means of a condenser control knob in the rear of the chassis. This is set at a value which will give good output over the whole range of 80M crystals and should need no further adjustment.

The second 6V6G acts as a 20 meter doubler or 10 meter quadrupler with only one coil for both bands. This coil is soldered across a 150 mmfd. midget tuning condenser and covers the 10 meter band near minimum capacity and the 20 meter band near maximum capacity. The 10 meter output is nearly as great as on 20 from this 6V6G because of the better LC ratio and a small sized by-pass condenser in the cathode circuit. This provides from 5 to 10 ma. of grid current into the HK24 buffer or doubler stage since the latter is biased to a high value at all times for more effective doubler action. The latter is needed for 5 meter output.

The HK24 buffer or doubler stage is inductively coupled to the push-pull HK24 final amplifier. These HK24 tubes are very effective for 5 meter operation and will handle up to 200 watts input in the final amplifier. The grid to plate capacity is quite low and a pair of "6L6" neutralizing condensers provide fixed neutralization over the three bands. These neutralizing condensers have isolantite insulation and adjustable plate spacing between two disks about the size of a silver quarter. Approximately 3/16

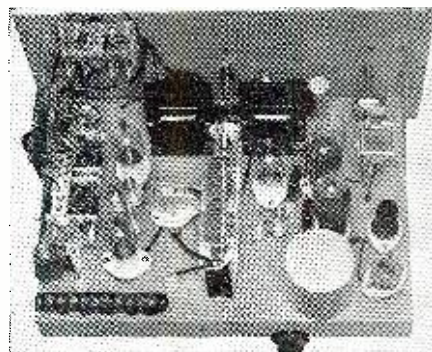

Note the simple arrangement of the component parts for direct leads.

inch spacing provided neutralization.

All r.f. leads in the final amplifier are quite short because of the small size of all parts and the placement of these units. Special coils were made by the coil manufacturer for these three bands, these coils have variable link coupling to the antenna feeders.

Cathode bias resistors in all stages protect the tubes in case of failure of excitation. An overload relay provides additional protection in the power supply system. Relays in the antenna and power supply circuits facilitate remote control and allow the use of an efficient antenna system for receiving as well as transmitting. All

(Please QSY to page 50)

COIL DATA		
Band	Buffer	Amplifier
20 Meters	14 turns No. 22 Enamel, 1 3/4" dia., 1 3/4" long.	14 turns No. 12 Enamel, 2" dia., 3 1/2" long.
	Grid coil—6 turns wound over center.	3 turn variable link.
10 Meters	8 turns No. 22 Enamel, 1 3/8" dia., CT 1 3/8" long.	8 turns CT No. 12 Enamel, CT 3" long.
	Grid coil—4 turns over center.	3 turn variable link.
5 Meters	4 turns No. 22 Enamel, 1 1/4" dia., 1 1/4" long.	4 turns CT No. 12 Enamel, 2" long.
	Grid coil—3 turns over center.	2 turn variable link.
	1st 6V6G plate coil—20 turns No. 22 Enamel, 1 1/4" dia., 1 1/4" long. (40) meters.	
	2nd 6V6G plate coil—5 turns No. 18 Enamel, 1 1/4" dia., 1" long. (10-20) meters.	

## WHAT IS HIGH FIDELITY?

ONE hears a great deal nowadays about High Fidelity Transmission, and a great many claims are made on this basis, some of which are hardly justified. High Fidelity means that the transmission is so close to natural that the human ear cannot detect deviations. To fulfill this requirement three items must be considered. They are Frequency Response, Distortion Factor, and Phase Shift.

The audible range of frequencies is between 30 cycles per second and 12,000 cycles per second, approximately. That is, from about three octaves below middle C to about five octaves above it. Hence it follows that in the matter of frequency response at least this range must be transmitted without noticeable attenuation of any part of it. Now, since variations of about 2 decibels are discernable to the average ear on sustained notes, it follows at once that the frequency response must be within this limit. For the layman, 2 decibels variation merely means about a 25 percent variation in loudness.

Considering next distortion factor we find that about the minimum which human ears can detect is between 3 and 5 percent, so obviously, high fidelity transmission must maintain a maximum distortion factor well below this value. As to the nature of this distortion, it is chiefly the introduction of harmonics (multiple frequencies) of notes already in the transmission. Such harmonic frequencies are, of course, extraneous, but will become apparent exactly the same as legitimate frequencies, usually with unpleasant results.

Phase shift is a matter which receives little or no consideration, but can become as important an item as either of the other two. To explain phase shift we must consider first a single sine wave or pure tone. Every time this sine wave passes through certain pieces of equipment it is slowed up by an amount very nearly one-half wave length or in terms of time, one-half cycle. This slowing up is in terms of cycles and not seconds, so that it may readily be appreciated that low frequencies are going to suffer most in this process. A 30 cycle note need only pass 60 such devices before it loses a complete second, while a 5,000 cycle note must pass 10,000 of them before it loses a second.

Now, since radio transmissions are made up of very many sine waves of all values in the frequency range transmitted, it follows that if there are very many devices in the circuit capable of slowing up these waves, some of them are going to come out noticeably behind the others. Various tests show that 1/10 of a second variation is noticeable in certain types of transmissions, hence if true high fidelity is to be attained, with a low frequency cut-off of 30 cycles per second not more than 6 phase lagging devices can be permitted in the entire system. Among the various pieces of transmission equipment guilty of causing these phase shifts we find audio transformers, long telephone lines and certain types of microphone units.

(Continued on page 46)



# What's That Noise?

by CHARLES MAGEE ADAMS

Milford, Ohio

**That noise you hear in the radio might be static, but it might also be any one of a number of man-made electrical interferences. The author tells you how to trace and cure local QRN.**

If there's one affliction common to *radio sapiens*, that affliction is noise (meaning something other than a swing band or superfluous CQ-ing). No spot on the globe is entirely free from it. The finest receiver and aerial system are not proof against it.

The 57,000 varieties of radio din fall into three main classes: natural static, electrical interference, and set noises. Nothing can be done about static. But plenty can be done about electrical interference and set noise. So before a case of QRN can be licked it has to be pigeon-holed.

Only radio sophomores will laugh that off as "elementary, Watson." The dividing line between the classes

from minute to minute. A crash like somebody dropping a manhole cover may be followed by a "dull sickening thud." After that may come a rustling like stiff paper. Mother Nature seldom does the same thing in the same way very long.

On the other hand, man-made noise generally has rhyme, if not reason; that is, a rather definite time or audio pattern. As a rule, audio characteristics are the trademark of electrical QRN: a.c. buzz, click, whirr, or sputter. But many noises also follow a set rhythm as closely as a dance band. Usually, too, the volume of a given noise remains about the same. In short, like man himself, his static is pretty much a creature of habit. And this helps a bedeviled dialer to track a noise to its source.

The only place where electrical interference can be cured completely is at its source. So, as the medicos would say, the focus of infection has to be found before treatment can begin. In other words, identifying the probable source of noise is at least half the battle.

Suppose then the noise that's blighting reception has been identified as man-made, not static. What's the next step?

The ideal method would be making an oscillograph record and comparing it with a master file, after the manner of the *F. B. I.*'s fingerprints. But there's a simpler way that's quite satisfactory for practical purposes.

Most types of electrical interference can be classified much like fingerprints. They fall into four main divisions: simple click, click and whirr, steady a.c. buzz, and sporadic a.c. buzz.

Whenever an electrical circuit is opened or closed, a click will be heard in a nearby radio. The commonest is that of a light switch. Notice that the noise is clean and sharp, without sputter or a.c. note.

The same sort of noise is caused by electric refrigerators, thermostats, traffic lights and other automatic equipment. The trick is to associate the click with its source. Sometimes

that's easy. Again, it takes a bit of Sherlocking.

Sign flashers are an example. Their clicks have a set rhythm, slow or rapid, in step with the flashes. By watching and listening at the same time, the culprit can be spotted.

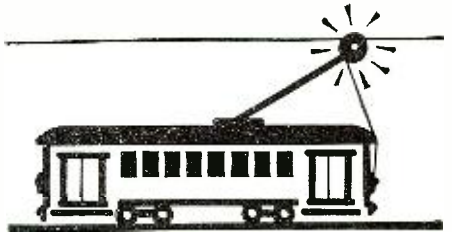

The trolley contributes plenty QRN.

Apartment-house elevators also betray themselves by the pattern of their clicks, especially if the motor has an automatic starter. The rhythm of dial telephone clicks will vary according to the dialer's speed.

But the granddaddy of all click-makers is the automobile ignition system. Strictly speaking, spark plugs produce a broken buzz. Practically,

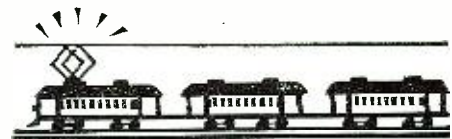

The fast train leaves many sparks.

however, the spark is so short that it seems a sharp click. On both the short waves and the broadcast band ignition should be suspected whenever a series of clicks shows erratic variations in speed or pitch.

Except in apartment-houses or along main highways, simple clicks are the least of the listener's interference worries. But click and whirr is another matter.

The whirr is caused by a universal motor. Sewing machines and mixers are typical. Particularly in or near

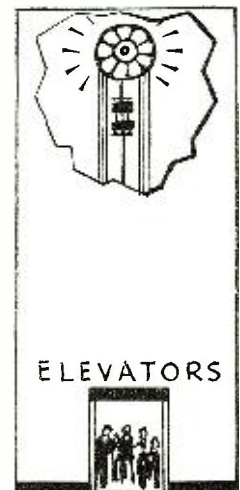

Noisy elevators.



The Violet-Ray machine is at fault.

of QRN is so vague that just cocking an ear isn't enough.

The first step in pigeon-holing a noise is to disconnect aerial and ground. Then a well-shielded set should bring in only strong locals. If the noise is just as loud as with aerial and ground connected, the trouble is in the receiver. Seven cases out of ten, however, it will vanish or be far less. Which means it is either static or man-made QRN.

The difference between them used to be quite simple. If it crackled it was static. If it buzzed it was electrical interference. But modern receivers pick up forms of static that couldn't be heard a few years ago, and man is creating a thousand new kinds of electrical QRN.

The chief thing that distinguishes static is still a crackle. In addition, however, the volume generally varies



Lightning cannot be eliminated.

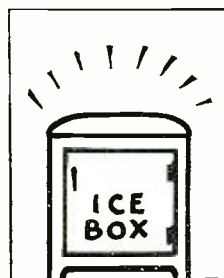

Troublesome boxes.



# What's **NEW** in Radio

All Electric Co., 1522 No. Clark St., Chicago, Ill., announce a new line of fluorescent auxiliaries of the magnetic type. These units are available in sizes from 15 to 40 watts. Compactly constructed, these fit every standard size lamp fixture. Machine wound, the coils are impregnated to insure uniformity of



performance under all conditions. These auxiliaries have no delay in starting that is apparent to the eye and cannot be heard even in a desk fixture. Other features include fine silver contacts, annealed magnetic iron laminations and modern construction.

Consolidated Wire & Associated Corps., 526 So. Peoria St., Chicago, have added a new type television antenna to their line of merchandise. This dipole consists of two telescoping brass rods which allows for exact adjustment to be made to the frequency picked up by the television receiver. Chromium fittings give an attractive appearance

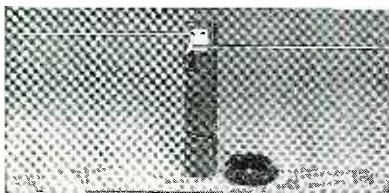

to the unit. An especially designed, low-loss, transmission line is used to further add to the overall efficiency of the antenna. The input impedance of the antenna, 100 ohms, will match the input of every television set. Complete information may be had by addressing a card to the manufacturer.

The Carrier Microphone Co. of Inglewood, California, recently announced their type 702-D Dynamic Microphone. The professional appearance of this unit, plus its outstanding performance characteristics is due to the "Acoustic Equalizer" and makes possible a response curve whose linearity surpasses that of previous types. Individual curves are available to the purchaser upon request and upon receipt of the serial number appearing on the unit. This model is available in standard impedance ranges of: 30, 200, and 500 ohms.

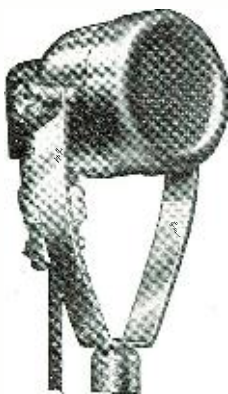

Hytronic Laboratories, 76 Lafayette St., Salem, Mass., are now making the Bantam type tubes available with special low-loss

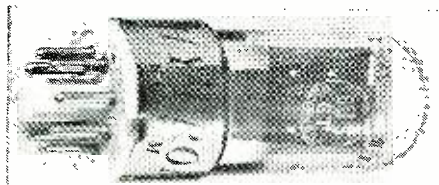

ceramic bases. These types are especially designed for use in amateur communication

receivers. Laboratory built, they are tested for use where maximum signal gain and stability must be met at high efficiency. The following types are now available: 6A8GTX, 6J5GTX, 6J7GTX, 6K7GTX, and 6K8GTX. This series of "Bantam" tubes is being limited to the octal type of bases and when it is desired to use a ceramic-based tube in a receiver using the older types, it will be necessary to change the sockets.

Mueller Electric Co., 1583 East 31st St., Cleveland, Ohio, present a new "60" series of alligator clips to their line of accessories. These units are available either insulated or non-insulated and include a unique solid copper Alligator for radio-frequency work. Features of improvement include the finely meshed teeth of the jaws, a comfortable thumb grip, and a choice of screw connection or soldered connection types. The older clips will be known as a "Crocodile" clip in the future.

Ward Leonard Electric Co., Mount Vernon, New York, have brought out a new Safety Relay to be used in amateur transmit-

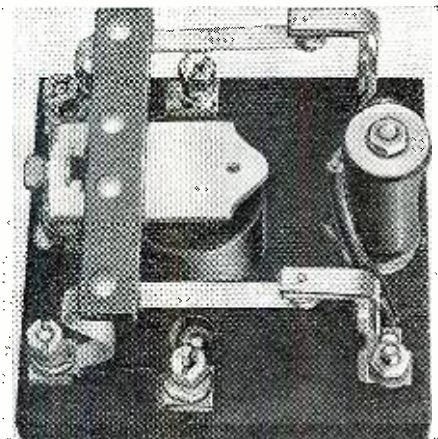

ters to short out the high-voltage supply after each transmission as a protection to the operator. This unit is known as model 507-546 and is described on their bulletin No. 5070 which may be had by writing direct to the manufacturer. This item is a timely addition to this large line of relays. The contacts close when the power is removed from the primary of the plate transformer and these short out the filter condensers and discharge the stored energy.

Browning Laboratories, Inc., 750 Main St., Winchester, Mass., recently announced a new



Visual Frequency Meter for amateur applications. It is so designed that amateur bands are spread over approximately 240° on a 5½" nickel-silvered dial which is calibrated in megacycles. The ingenious circuit devised makes it possible to check the instrument against transmissions of WWV for accurate frequency adjustments. An electric eye is used as an accurate zero-beat indicator. That the frequency meter may be set to a precision of at least two parts in 70,000 is claimed by the makers.

International Resistance Co., Philadelphia, Pa., announce new midget controls with universal shafts. These controls use the metalized type resistance element, heretofore

available only in the larger units. Among the features of this new product are the spiral spring connector which eliminates wiping, metal-to-metal contact between rotor arm and center terminal; the 5-finger knee action silent-element control and a special

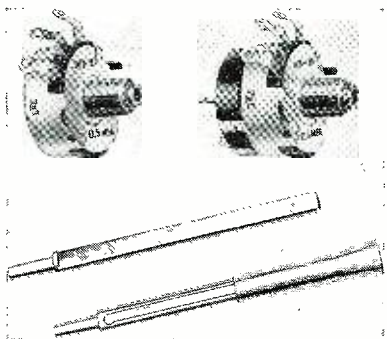

steel coil spring on the shaft is used as a thrust washer to eliminate end-play. The case diameter is only 1-9/64". A plug-in shaft is packed with each type D control and is designed for use where definite flat location is needed.

Littlefuse Incorporated, 4238 Lincoln Ave., Chicago, announce new "VIDEO" fuses to meet the requirements of television receivers as they make their appearance on the market. They have two important functions: to protect the equipment, and, to protect hu-

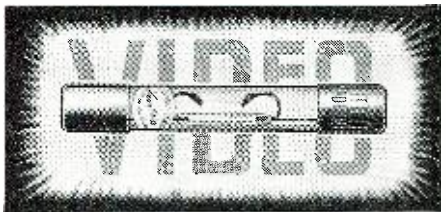

man beings from equipment. Six sizes are available in resistance ranges of from 1/1000 to 1/16 amperes. Because of the vacuum enclosed feature, these fuses break unusually high voltages—20,000 volts peak being the maximum. Physical size, 1¼" x 9/32" dia.

Clarostat Mfg. Co. Inc., 285-7 North Sixth St., Brooklyn, N. Y., are now manufacturing a Ferrule clip terminal type resistor for the Clarostat wire-wound power resistor line. Ferrule clip terminals are available for units ranging from 10 to 200 watt ratings.

International Resistance Co., 401 N. Broad Street, Philadelphia, Pa., introduces a new line of resistors for high voltage protective and measuring devices. These resistors are available in five standard sizes. Resistance values are maintained to plus or minus 5% in standard applications and will stand as high as 50% overload.

Allen B. DuMont Labs., Inc., 2 Main Ave., Passaic, N. J., announce that their C. R. tubes have been given several times the structural strength with an egg-shaped blank with which they are provided.

The second DuMont innovation is the introduction of one or two gold rings deposited on the inside wall adjacent to the screen, providing for the intensifier electrode which accelerates the electrons after deflection. The tubes are made in 5" and 9" sizes.

The Thordarson Electric Company of Chicago has published a new amplifier guide, No. 346-D. This publication covers the various types of amplifiers, ranging in power output from 8 watts to 120 watts, and one of the outstanding features is that the chassis layout dimensions are actually given. Among the many amplifiers shown, several are ideally suited for use as modulators in amateur transmitters. One page is turned over entirely to the description of the general testing of various types of amplifiers.





ONE of the funniest stories to develop out of a ham's desire to own and maintain a telephone pole for the support of an array happened to Bert Heivelman, W9ZYB.

It seems that Bert has coveted one of those there poles for years and years and years. This he did secretly and finally openly. One day his chance came. It was after he had done a favor for a minor official of the local telephone company, that that worthy offered to do something for Bert. Did ZYB jump at the chance? He did, and asked if he could please have the 'phone company deliver him a pole. That would be arranged, he was assured by the official. In due time, Bert was told, his pole would be delivered to his home. Bert was to ask no questions and to act as if he had been expecting it all along. Three weeks later a very sweaty and tough individual rang Bert's bell. Was he expecting a telephone pole? Yes, he was, and Bert rubbed his hands in elation. It seems that the pole was just down the street a bit, but the bell-ringer would deliver it into Bert's back yard. Could Bert see it before delivery? Certainly.

Walking down the street a few hundred feet, Bert spied his much-sought-after telephone pole . . . it had been neatly cut into 3' lengths so that it would just fit a fireplace! P.S. Bert still is looking for a good telephone pole—in one piece—to erect that directional array! Hi!

W9ETI reports that he has been working all kinds of DX with his portable and an input of 18 watts to an RK56 (No advt!). The band was 28-30MC.

W9ISR had a present made to him of a 2,000 volt, 300 ma. power supply. The donor was M. W. Thompson of the Farnsworth Television Corp. Nice goin', John!

Several hundred hams attended the preview of the \$5,000 RADIO NEWS 1940 ALL-PURPOSE TRANSMITTER-RECEIVER.

W9UG, *The Globe Trotter*, will be on a big time radio program soon, it is rumored. Wish you all kindsa luck, Umer!

W9BP has a stunt that may revolutionize radio.

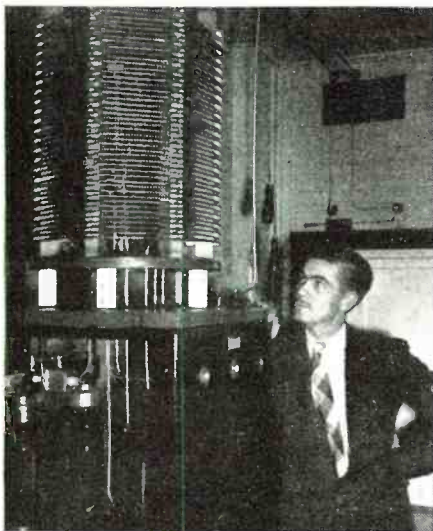

Chief radio engineer Harrington, of Mutual Tel. Co., Honolulu, was the 1st to talk across the Pacific in 1908.

One of the swellest conventions we ever attended was that of the Mid-American gang at Minneapolis. This wide awake bunch put on a show that had all the earmarks of a national convention. The banquet was attended by over 1,000 persons, and the prizes left nothing to be desired. Funny thing, though. One ham legitimately bought two tickets, and won on both! One got him first prize, too. Some people have all the luck!!

The Milwaukee QSO Party was a huge success also. The speeches—of which there were a total number of exactly ONE—was fine. A large turnout heard RIG Matthews, ARRL Director, give his report of his stewardship for the past year. Good entertainment was also furnished.

(Aside to Fred Cate of Milwaukee Gang: Don't forget me next year, Fred!)

FROM the hook: "Pull your tongue out of your cheek, OM, you'll never find an easier way to get worms for fishing. . . . P. T. Booth, W7FTA." OK,FTA, our tongue is out of our cheek, es tux fer qso'ing!

Windy Bill, W5HMV sends along his picture and that of his shack so that we may have the pix of a W5 in our column. Tux a lot Bill, and here it is!

W9MMC is a new ham on 7mc. Watch for him, he wants skeds es tuff.

W9OCN is rebuilding to a TZ40 in the final wid plentya watts.

(Aside to J. Mullancy: Tux fer the dope on the above.)

W9TLE certainly can convene a swell convention, and W9JDO can round up some swellegant entertainment—private and public!

Congrats to W9MZN, Dakota Div. ARRL Director, fer a fb job at the board meeting.

When it comes to maistroaches of ceremonies, we'll pick W9CW1 every time.

Does anyone know what has become of the "ants" that W9LFU has been lecturing on?

A hamshack has been established by Wholesale Radio Service Co., Inc. at 100 6th Ave., New York City. Here hams can try out new stuff 'n things. Don't forget to visit it and visit with other outa town hams there.

W9VH, says that he holds a record as a convention-goer-to. He has attended 15 consecutive shindigs. Come from the Beer City in Wisc. Anyone dispute his statement?

If any New Zealand hams want some nice radio magazines, pleas write to W6MDQ, George H. Leber, 508 Barnes Avenue, Baldwin Park, Calif., who says that he will be happy to send them on. This is a very fine thing, you want to do, MDQ, and a big bunch of orchids to you fer your intentions!

FROM the mail bag:

When I substituted for a band-director friend of mine a few weeks ago at Livingston, Texas, of course, a ham rig went along with me, but I carried only the bare necessities, including a push-pull '47 xtal osc. (7 mc.) Since I only expected to be there a little while, I planned to save weight by constructing the power-supply after arriving, and even left my pet Balwins in favor of a pair of lightweight cans. The only power transformer I could buy being a 200-volt one from an old Philco, I feared that W5FPJ/5 would not be heard, considering that the house was surrounded on three sides by telephone, telegraph and power wires, respectively. There being no place to hang a sky-wire, I heaved a half-brick, to which was attached a roll of dime-store antenna wire,

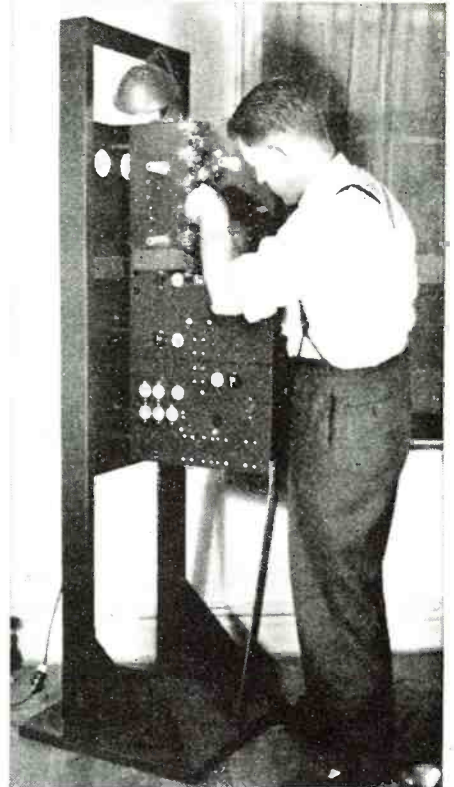

Vinnie Ulrich working on a new xmtr.

over the two-story house, and coupled my peanut-powered palpator with a 12-foot twisted pair to the tuner of my make-shift Marconi.

One Sunday morning at 7:15, CST, according to my log-book, after careful tuning, with the antenna and surroundings drawing 5 watts, I unleashed the fury of W5FPJ/5 upon the ether. I had tuned for several minutes looking for a W5, feeling it no use to call anything out of my call area. Amid a horde of W8's, W4's, etc. I heard a CQ by W5GWP/? and called him, having missed his portable call area.

Yes, you guessed it: He answered me, gave me a 569x rept, and stated that he was working portable in Ocala, Florida

Now for the SWL yarn, a short one: A SWL told me that for months he had been wondering where CQ, the popular rascal, was located, and that the night before he had discovered that CQ's QTH was somewhere in Alabama. W9LME may pass along this bit of info about CQ to his SWL friend.

BASIL C. BARBER, W5FPJ.

W3GNU reports that the Delaware Valley Radio Association's amateur radio display at the Trenton, N. J., YWCA Hobby Show created great general interest. The



Wholesale's new Hamshack in NYC.



show was held May 10th through 13th. The Association's station W3AQ operated on all bands during the exhibition. Assisting with the demonstration were W3CCO, W3ZI, W3EUH, W3VE, W3AFH, W3HWO, W3FNL, W3HTJ, W3CFS and W3GNU who put on the show. It is this sort of thing that helps ham radio lots!

The same club wishes to tell all and sundry that it will hold its Third Annual Outing and Hamfest, Sunday, August 6th, from 10 A.M. to 8 P.M. (If it rains, the party will be postponed till the 13th. The outing will be at the Trenton State Fair Grounds, Nottingham Way, Trenton, N. J. Direct bus service from the Pennsy Station. Some of the attractions include a Big Champ Baseball Game to be played between the 2nd and 3rd Call Areas, two orchestras for tripping the light fantastic, prof. entertainment, prizes for the YL's, XYL's es OM's. Mail all reservations to W3GNU, Hightstown, N. J. Traffic, \$1.50 per adult, 50c per junior ops. You can save two bits by mailing reservation early before Aug. 1. Don't pass this up!

**F**ROM the raised eyebrow dept.: Wonder why the ARC editors are so hot under the collar about the efficiency experts going into ARRL business affairs which was ordered by the Board at their last meeting. This specially funny since their own Director, H. L. Caveness, voted FOR this motion, as did ALL the directors. What tops the whole thing is that this same Mr. Caveness enjoys the confidence of the Board so much that he is one of the members of the committee to select the firm of efficiency experts. Can it be that the ARC does not agree with Director Caveness? Personally, we think him to be one of the most level-headed men on the Board!

Excerpts from W4FIX's colyum in the ARC: Watch for Gibraltar, ZB2D (4120-49), ST6KR (14310), VK7KR (14345-49x). If you need Nevada for WAS look for W6QQL, Boulder City, Nev., on 14368; fer Delaware, try W3DPA, 14376; fer Vermont, its W1FGO, 14370; North Dakota, has W9LLP, 14320; and Utah is represented by W6KKG es W6LPP on 14395. Tnx 4FIX fer the dpe.

**F**RANK LYICC DRUKTEINIS, of Seinu 9, Kaunas, Lithuania QSO's to advise that he is on the air with 100 watts from 03.00 to 04.00 GMT on 14004 or 14076. This ham station does a real broadcasting job with Lithuanian music and folk songs with short English announcements. Watch fer him, he will QSL all crds received.

All N. J. Hams are requested to send their requests for 1940 NJ ham license plates for their cars to W3CZN. The petition was published last month in the HC. Further dope on this is available fm 3CZN.

Excerpts fm "Bandspread," the lively Greater Camden Amateur Radio Assn mag. . . .

W3AGK heard on 20 fone—Don't miss the Picture "The Storm," deals with Amateur and Commercial radio. Another one is "Jury Secrets" to be released soon . . . Seems the Ham bands are taking a vacation again as the Summer nears . . . 1942 is said to be the year that conditions are going to change for radio. Let's hope it will be BETTER . . . RADIO NEWS and "Television" is getting to be a very good magazine for the Amateur.

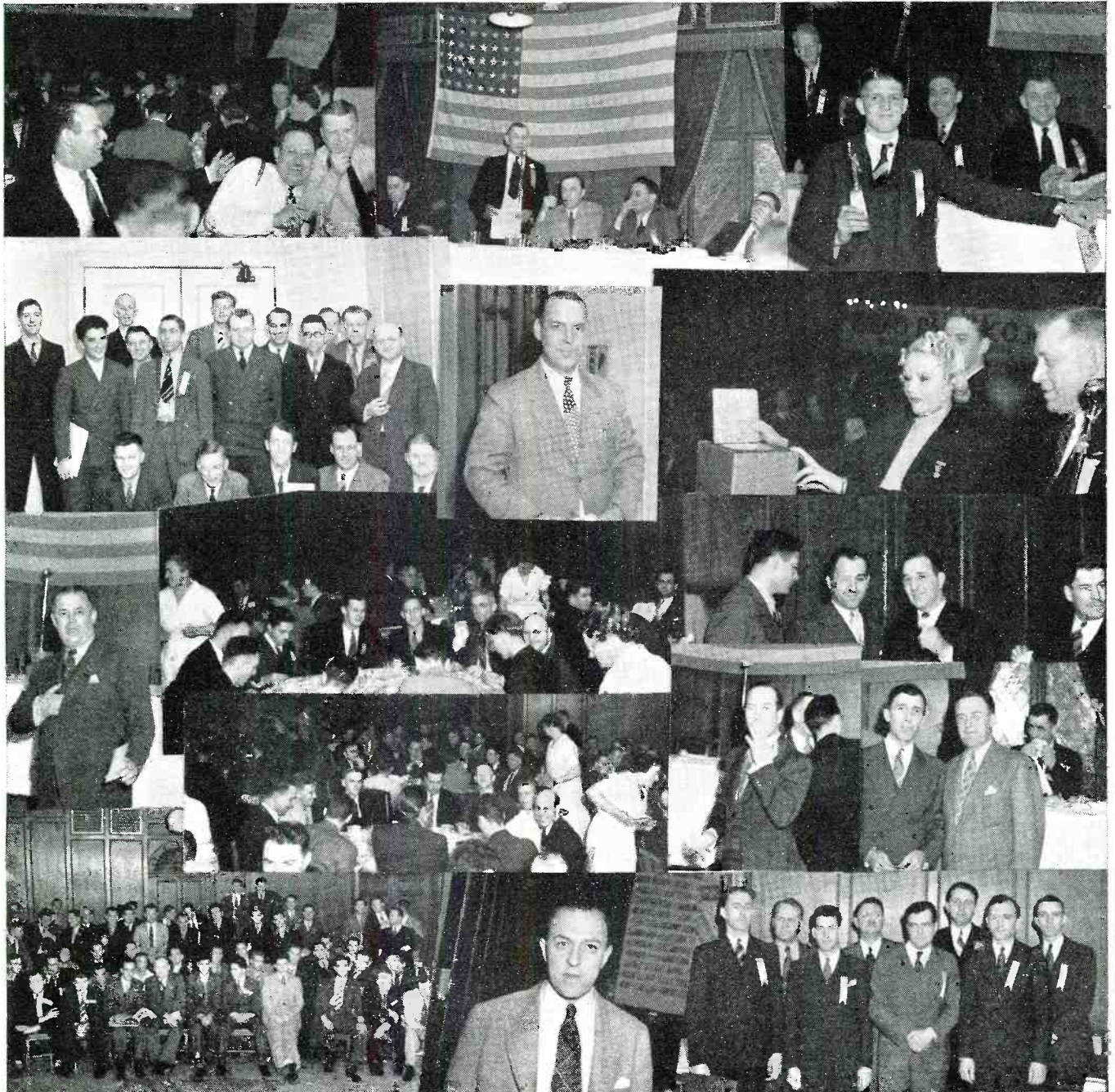

**The Milwaukee QSO Party**



Lots of new dope . . . W3TR sure works the DX, has 108 countries . . . 3BES wins the 9th Sweepstakes . . . 84,000 points, using a pair of 809's in the Final. Nice going, Jerry . . . 9CNS claims to be the oldest Ham, he is 78 . . . In the third Copying Bee Contest 3EEN was high with perfect copy at 25 per . . . 3CHE won the DX contest with a score of 181,000 points . . . 3ENC leaving for the West Coast soon . . . 2USA not on the air as yet, but will be on shortly with low power . . . There are 440 Amateurs in the city of Washington, D. C. . . The Philadelphia Electric Co. Radio Club was represented at the Baltimore Hamfest . . . We hope SWL Crowell is a full fledged Ham by now . . . SWL DeHaven was elected director of the Phila Electric Co. Radio Club . . . 3CAF was elected Pres, and 3CAA was elected director . . . 3CZN was chairman of the nominating committee at the Phila Electric Company Radio Club. The meeting and election of officers was held at the Edison bldg. where 5 meter activities was going on in full blast that night . . . 3ACB as operator in charge. 3NA is going in for DX . . . 3EML works

20, 40, and 80 . . . 3HWC is hearing a little DX these days . . . 3CFL is inactive due to some business activity. W3HWC is in the market for some speech equipment. John intends to put up an antenna mast from the former 3APC . . . SWL Hamilton visited the RI, but no go. He intends to put up an antenna in the next two months. Better luck next time, OB . . . W3AYZ gave a FB talk on "A Visit to the New York World's Fair" . . . We wish to thank W3AYX, 3CZN, SWL DeHaven and Crowell for the nice cakes they donated to Club, the ice cream was swell . . . SWL Crowell won the call book at the last meeting . . . 3DEK says business is getting better . . . SWL Sooy is back from N.Y. and out of work . . . We wish to thank Mrs. J. Werner for helping with the Club paper . . .

**W**9UFU handed us a big surprise by coming back with his other call. We didn't know he also is known as W9ZBL. Maybe we will hear him more often now. W9FDT has finally succumbed to the lure of fone. George has always been a CW man.

Wonder if the fact that he works at a broadcast station has any bearing on his capitulation to the fone bug.

Funny how the foreign hams can get out with low power while our boys need as much soup as the law allows. For instance:

VK2OR uses 25 watts input on forty meters;

VK4EI has 20 watts and VK2GJ with 38 watts.

VK7KR, a Tasmanian, Charlie has only 16 watts;

F3CY 100 watts;

VK4ER 25 watts;

VK5RT 25 watts;

ZL1HY 100 watts;

VP5AF uses a pair of 45s pp.;

VK51B 24 watts;

VK2NO 40 watts;

K5AZ 25 watts.

VK3KN 25 watts CW and his fone rig

uses only 50 watts;

VK2ED uses 40 watts;

ZL1BR 100 watts;

K6NSD 100 watts;

K6IDK 100 watts;



**The Mid-American A.R.R.L. Convention**





Geo. (W9FYC) Trostle, Sibley, Ia., whose 14 mc. rig really does big DX. VE1NU 70 watts; VE5GS 25 watts; EA8AH 190 watts; LU1AB 50 watts; and VE1EX with 60 watts.—These fellows get out very nicely.

VE4APE visited W9ISR but all efforts to contact Winnipeg on fone were to no avail until the visitor had gone. It seems the old Jinx is still working overtime.

W9HQH tells a good one about the time he was working ZL2AN on forty meters. The qso had been going along quite merrily for a while both sides being solid copy when HQH decided to see if he could get out to New Zealand on 75 meters. He arranged for the zedder to look for his fone making a sked to meet later on forty in case the fone rig fell down on the assignment. Frank got a bit excited making the call on the fone rig and got the ZL's call slightly mixed. Instead of calling ZL2AN, he called ZR2AN. The rest didn't work as the New Zealander could not hear any American stations on 75 meters so Frank had to complete the contact on forty where it had started. A half hour later imagine his surprise when he got back on 75 meters and heard a couple of fones still calling ZR2AN. Hi!

It would seem that the boys were either kidding themselves or by some queer coincidence the boys were hearing phenomenal DX on 75. "Quick, boy, page Prof. Zilch."

Another strange thing happened on the 14 mc. band. VK2\*\* called a nice long loud CQ and of course had his choice of the band as far as the Ws were concerned.

Later, we heard three stations working this same VK at the same time but the VK was still working one and only one of the three W stations.

Aside to ARC Mag Editor: In re "Der Tag"; Touché? In re Nazism; Touché again? In re ARRL; sorry ur wrong, we're an Asst. Director! hi!

SOMETIMES one of the boys gets an idea to go places and has a break in financial matters at the same time. The repercussions that follow are interesting so we will set



The Biggies get together at Mpls.



W5HMY, known all over as "Windy Bill" sports this very swell looking rig.

down in imperishable type the experiences of one lad over on the east coast. It is not necessary to mention his call; he might not properly appreciate this literary gem anyway.

His sudden affluence came at a time when he was just about to give up ham radio as a bad job. Sleepless nights spent in quest of elusive DX and overpowering QRM just about had him licked.

He had never tried fone, so naturally the new rig would have to be a fone rig.

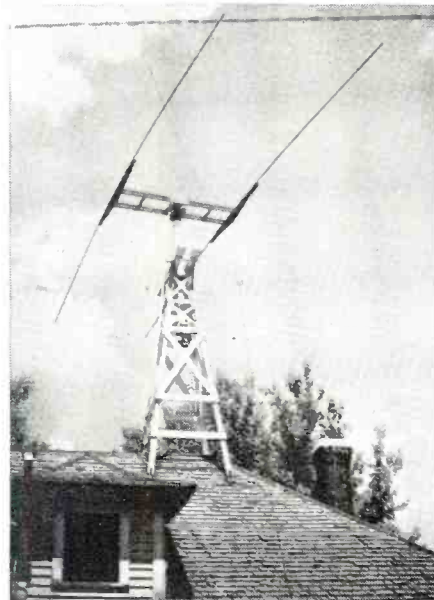

The rotary Amplex beam that W9FYC uses to catch the elusive DX WAC.

The class "A" ticket so long unused was to be dusted off and oiled up. We have all had the fun of building our first real rig so we won't go too much into detail about his troubles in the construction stage. Suffice it to say, after having the floor calibrated so that he could estimate the various voltages at a glance or should we say "jump," he finally got the thing on the air.

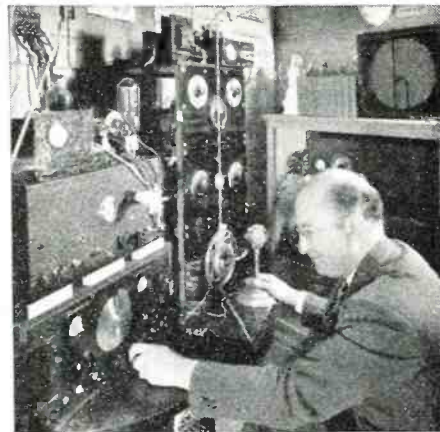

W9SZW-W9TMQ, author, dentist and ham, whose calls are heard on 5-10, & 160. Between 35 and 100 watts used.

Now a masterpiece must have the proper setting so our hero got himself the latest thing in four-element rotary beams. It was necessary to reinforce the roof beams but that is only a small matter when one is fired with the proper zeal.

He is now a WAC WAC (worked all con-



W9HNQ experiments with 112 mc. in his car, and finds that it really works.

tinents without Asia Club). His neighbors have decided it is useless to listen in on the broadcast band. Most of their sets have dead RF tubes anyway.

But the worst thing was that they have had to develop a grass that will grow in that atmosphere of RF. At first the grass simply died as soon as that four element beam was swung around but now the folks have planted a new kind of grass that grows in coils. This RF grass is fully capable of withstanding terrific RF loads. One of them even developed a grass which has bypass spurs growing out of each pie in the stalks of grass so now the green lawns around in the neighborhood near his shack are just as nice and well kept as before the advent of his great affluence.

ALF MILLER, VE4UK in Regina, is going to put up a 3 element rotary beam in a few weeks. He has the elements, the (More Hamgab on page 48)



W8BPF places his rig on exhibition and catches a swell YL, Miss L. Long.



The receiving and control position of W2KBA. He has a fine remote system.



# The -m-o-n-i-t-o-r R-e-v-i-e-w

by **R. F. LAYCOCK**

Howard Radio Corp.  
Chicago, Illinois

***Including a frequency monitor within a communications receiver is a fine way to be able to check transmitters.***

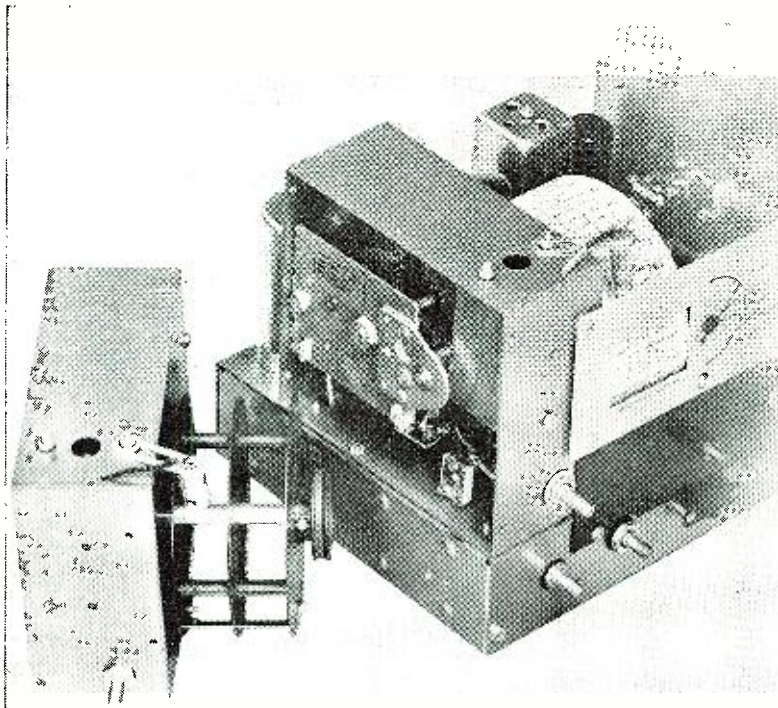

The construction and assembly of the freq-monitor.

THE unit herein described provides an entirely new and highly accurate means of frequency checking, logging, pre-setting and band spreading in communications receivers. This is accomplished by actual frequency measurement instead of reference to a chart or calibrated set dial.

To understand its use thoroughly, it is first necessary to know why it was brought into use and what it accomplishes. Heretofore, it has been necessary to rely on either an arbitrarily calibrated dial scale with reference chart, or a directly calibrated dial scale, to determine the operating frequency of a receiver. In the case of a dial scale calibrated directly in kilocycles, the accuracy would depend upon several factors. These were: length of scale, ability to read the scale accurately, accuracy of calibration, and the frequency stability of the receiver. In the case of an arbitrarily calibrated scale, the above would apply, with the exception that the accuracy of the reference chart should be considered. The accuracy of either dial would depend upon the receiver's stability. Inasmuch as all receivers drift to some extent over a period of time, it becomes necessary to use a new correction factor for the chart or dial if any degree of accuracy is to be maintained. Even with temperature compensation applied to the various control circuits of a receiver, drift in some degree is present. In locations where extremes of high or low humidity prevail, thus affecting the receiver's stability, it is paramount that

there be some means of checking operating frequencies.

If frequency checking equipment which may be relied upon at all times and under all conditions is provided, the probability error will be eliminated. Accuracy from this point on will depend upon the care with which the frequency checking equipment is read.

The *frequency monitor*, as the frequency checking equipment in the receiver is known, consists of a highly stabilized oscillator with fundamental frequency range of 850-1030 kc. The harmonic relation of the various amateur bands and their relation to the fundamental of the monitor is to be seen in the table below:

850 kc.—1030 kc.	Fundamental
1700 kc.—2060 kc.	2nd harmonic—160 meter band
3400 kc.—4120 kc.	4th harmonic—80 meter band
6800 kc.—8240 kc.	8th harmonic—40 meter band
11,900 kc.—14,420 kc.	14th harmonic—20 meter band
25,500 kc.—30,900 kc.	30th harmonic—10 meter band

Referring to the drum dial scale of the frequency monitor; the right hand scale covers the fundamental frequency. The other scales cover the respective amateur bands. The 16th harmonic of the fundamental should cover the 20 meter band and the 32nd harmonic should cover the ten meter band. If this doubling throughout had been continued, it would have been necessary to squeeze the scales to-

gether on the drum dial. If, instead, we pick harmonics so the scale can be lengthened as shown, there is little chance of error in reading due to small figures.

If a rule is laid across the scale reproduction, a straight line through 875 kc. falls also on 1750 kc., 3500 kc., 7000 kc., respectively, which are the 2nd, 4th, and 8th harmonics. A straight line through 912.5 falls on 7300 kc., which is the opposite end of the 40 meter band.

If the fundamental frequencies on the monitor scale are highly accurate, the harmonics will be likewise. By coupling the output of the monitor, through a suitable filter and attenuator, the network into the receiver's antenna circuit the monitor's accuracy may be checked by "zero-beating" with a known incoming signal on the receiver.

The accuracy of the frequency monitor is established by setting its dial so the fundamental frequency shown exactly corresponds to that of a known broadcast station within the 850-1030 kc. range. The known station tuned in on the receiver will then "zero-beat" with the monitor. If any discrepancy appears in the monitor setting, it will then be necessary to reset the monitor corrector for zero beat. The corrector is a trimmer across the monitor oscillator tuning condenser. The frequency of the monitor is exactly the same as that of the broadcast station.

It is quite possible to use WWV's signal on 5 mc. for a frequency check and thus establish the monitor frequency, but inasmuch as WWV's signal is not always available, the former method of checking would be more suitable.

The calibration of the monitor is based on an inductance having a value of exactly 100 microhenries, tuned by a condenser having a very accurately

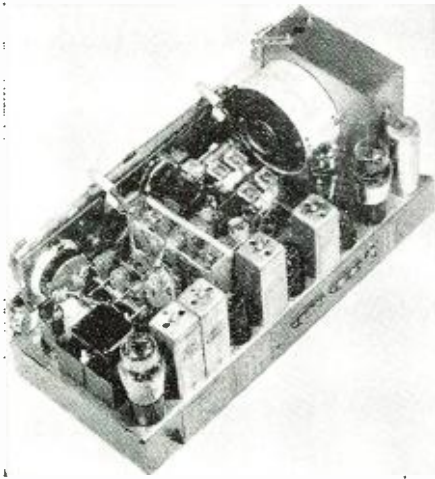

Inside the freq.-monitor receiver.

established capacity curve. Both the values of inductance and capacity remain constant. The necessary correction to establish true dial reading is made by a variable padding capacity. This is necessary to compensate for variations in tubes. Correcting the fundamental frequency scale of the monitor in this manner at any one spot will correct automatically the same amount at any other position.

An example for setting the monitor dial would not be amiss here. First, the monitor should be operating for at least fifteen minutes to obtain maximum stability before any measurements are attempted. Tune the monitor dial to any broadcast station, say, 870 kc. Tune in 870 kc. on the receiver using the "R" meter to determine exact resonance. Now, turn up the monitor attenuator and adjust the monitor corrector to "zero-beat" with 870 kc. Use the minimum amount of signal necessary from the monitor, to prevent any possibility of "zero-beating" with an incorrect signal.

First, the unit establishes the frequency of any incoming signal, whether that of a BC station or your own transmitter. Thus, the operating frequency of the transmitter is determined and it is possible to stay within the band limits.

It is quite simple to measure the frequency of any signal heard. With the band range switch of the receiver set for the correct frequency coverage, turn the monitor on and "zero-beat" with the incoming signal by tuning the monitor dial. Use monitor attenuator if necessary to obtain correct signal strength for "zero-beating." Station frequency may then be read directly on monitor dial.

Special care must be taken in reading frequencies in the ten meter band due to the possibility of images. In other words, it is possible to hear the monitor in two positions. *The true signal is the one of lower frequency.* Once the monitor is set, care should be taken that the corrector is not tuned accidentally.

In checking the frequency of your own transmitter, the same procedure would be followed. It probably will

be found necessary to keep the transmitter and receiver coupling at minimum to prevent overloading of the receiver or spurious harmonics of the transmitter entering into the measurement.

Band spreading by frequency reference will be found to be of great value once it is tried. It has always been known that if the starting positions of band spread can be established to be exactly the same in frequency each time band spreading is started, the starting positions and logging can be repeated accurately. In establishing these starting positions in the past, it has been customary to set the main tuning indicator as close as possible to the original or logging position. This, naturally, leaves much to be desired in accuracy because a slight error, even smaller than the eye can detect, would make a tremendous difference in repeating the same band spread dial reading. The older mechanical methods never corrected for these things. It will be noticed that on the Frequency Monitor dial there are positions indicated by an arrow, 1, 2, 3, etc.; these arrows indicate the limits of frequency span of the band spread and should be used as the starting position. For example, the 10 meter band starts at 30,000 kc. and covers to 28,400 kc. in the first step. Therefore, the second reset position is at 28,400 kc. The balance of the band is covered in the second setting of the band spread. By using the monitor also as a BFO we eliminate the harmonics that might otherwise prevail when the customary intermediate frequency beat is used.

The construction of the monitor is small and compact and requires more painstaking effort than the average receiver. The monitor housing is  $4\frac{1}{2}$ " x  $5\frac{1}{8}$ " x  $2\frac{3}{8}$ ". In this is mounted the precision tuning condenser and reduction gear assembly, also the frequency monitor coil assembly, trimmers and switch assembly. The tuning condenser has two 3.8" round steel bars at either end, and two flat steel bars at the bottom prevent any possibility of plate misalignment, once the unit is assembled. Steel cut gears mounted on a  $\frac{1}{4}$ " rod with brass bearings provide tuning reduction of 10 to 1. The  $\frac{1}{4}$ " rod is run through both sides of the condenser gang to allow for two brass bearings at either end, thus there will be no possibility of "side play" after a long period of use. Ceramic bar insulation is used between

rotor and stator both at the front and back of the front and back of the condenser. As seen in the illustration, the frame of the drum dial consists of three stamped steel plates held together by five  $\frac{1}{4}$ " rods. A collar with set screw at the outside end of the drum holds it in place on the  $\frac{3}{8}$ " shaft of the reduction gear assembly. The drum drive is by means of cord with spring tension control to prevent back lash. An end plate is mounted over the monitor housing and *not* left open as shown.

The oscillator coil assembly is mounted to the top of the monitor shield. The oscillator coil is iron core, high Q, with the core adjustment through the top of the monitor housing.

The monitor scale is  $2\frac{1}{16}$ " wide with longest scale length about 12". This allows plenty of room for the amateur bands so they may be read very easily. The lower frequencies may be read within 1 kc. and the higher frequencies with several kilocycles.

Directly below the monitor off-on switch, is the monitor corrector. This is a ceramic insulated variable condenser with maximum capacity of 25 mmf., and minimum of 5 mmf. Back of the frequency monitor case may be seen the oscillator tube for the monitor in its own shield. The shield is held on by a clip on the monitor case. A 6K6GT is used. Even though the plate voltage on the 6K6 is low, the output is more than sufficient.

The oscillator circuit is conventional with a shunt fed plate supply. High voltage supply for the monitor is well filtered through a resistor and by-pass network, for any possibility of stray pickup of r.f. leaks. The filament

(Pse QSY to page 48)

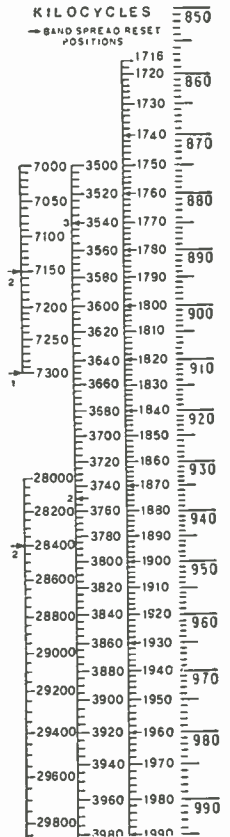

Station frequency measuring is easy with special scales.

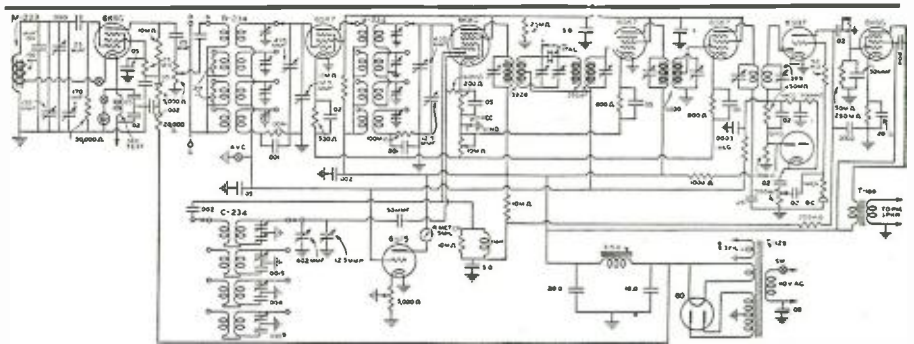



# Simple 112-118 mc. Transceiver

by M. N. BEITMAN

Engineer, Allied Radio Corp.  
Chicago, Illinois

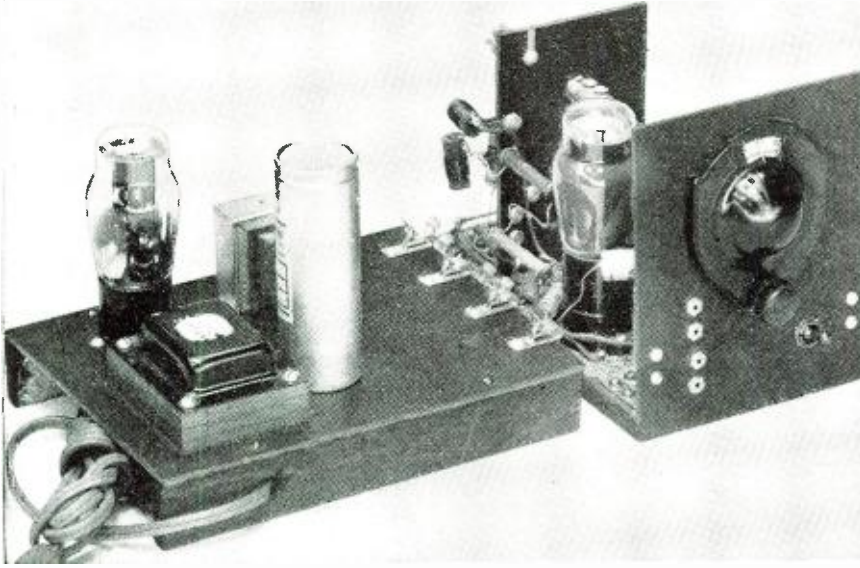

Two chassis comprise the entire station for 112-118 mc. work.

NEW interest has been aroused in the 112 mc. and this band offers worth while experimentation with inexpensive and easy-to-build equipment. Since the recent regulation placed the transmitters for 5-meter operation in the same class with its older brothers, the amateurs with the lean pocketbooks and the urge to explore new frequencies, turned to the 2½-meter band (112 to 118 mc.). In this band modulation of a self-excited oscillator is still permitted and the transceiver circuit is the natural selection.

There have been many circuits published that are adaptable for operation on this frequency. Sometimes these circuits are described as being primarily intended for 5-meter use, but a change of inductance is all that is needed to make the unit function just as well on 2½ meters.

Any triode, such as 76 or 6C5, having low inter-electrode capacities, can be adapted to serve as the oscillator for transmitting or for receiving as the super-regenerative detector. Modulation may be supplied directly to this tube without any audio amplification, but to obtain any effective percentage of modulation, an additional power tube will have to be used. Also, this audio tube will aid greatly in raising the audio level of the received signal, and under favorable conditions will actually operate a loudspeaker.

In the experiments carried out, the 76-41 tube combination was most commonly used, although other pentodes were tried for the audio section, and one of the transceivers actually used a metal-type 6C5 tube as the oscillator-super-regenerative detector. Attempts to use a master-oscillator power-amplifier type of circuit did not work out very well.

The suggested lay-out illustrated will give very good results. However, this lay-out need not be followed so long as the tuning controls are kept away from the terminals of the oscillator tube, and the tuning condenser and coil are close to the termination of these prongs.

A brief study of the recommended circuit will indicate the method employed for switching over from the "receiver" to the "send" position. Actually in the "receiver" position, the type 76 tube acts as a super-regenerative detector feeding the type 41 tube as an audio amplifier. When the switch is turned to the "transmit" position, the type 76 tube becomes an oscillator and automatically has its grid leak resistance reduced.

The type 41 tube, now is excited by the signal from the microphone transformer and serves to plate-modulate the oscillator section. Excessive "B" voltage will prevent oscillation, but a simple power supply, such as the one shown in the schematic diagram, will

**Just the rig with which to start your exploration of the 112-118 mc. band. It does a good job on short distances.**

serve you excellently for this purpose.

In the "receive" position the rushing-hissing noise associated with super-regenerative receivers will be heard until the carrier is tuned in. This will immediately reduce or completely stop this noise mentioned, and the audio signal used to modulate the carrier should be heard.

A loop of wire and a small dial light will serve to test the intensity of oscillations and permit you to make the needed adjustments. The bulb will glow more brightly when the unit is in the "transmit" position, but should indicate some radiation when the receiver is used to pick up signals. In the "transmit" position the intensity of the test lamp should vary in accordance with the modulation placed on the microphone.

(Pse QSY to page 52)

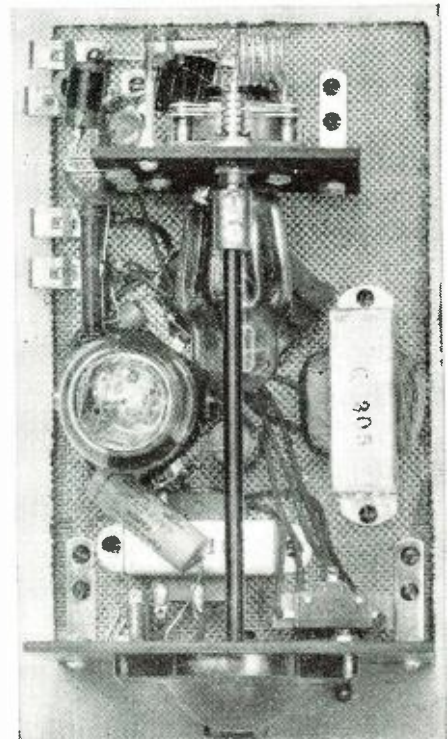

Note the compactness of the various component parts. Simple to operate.

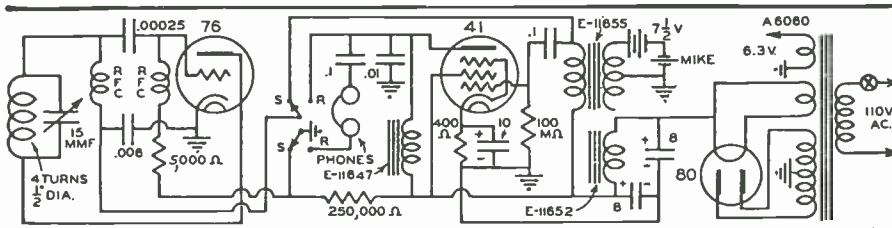

## TECHNICAL BOOK & BULLETIN REVIEW

THE TELEVISION SALESMAN'S HAND BOOK, published by the Allen B. DuMont Laboratories, Inc., Passaic, New Jersey. It has been printed for the prospective television customer and contains a complete description of television together with an explanation of the various terms and phrases used in this new art. Inasmuch as the terms used to describe and explain television are new to most radio listeners, this book will serve as an excellent guide in presenting these new terms. Illustrations of modern receivers are given together with a brief technical description which covers the explanation of what actually takes place in both transmitting and receiving the television picture.

The Kenyon Transformer Company of 840 Barry Street, New York, N. Y., have just announced a new 14 page catalog fully describing their T line of Transformers. The catalog features new apparatus and contains diagrams showing various amateur power supplies and a complete chart of driver and modulator combinations. Also various circuit diagrams of amateur speech and audio equipment with complete circuit constants. A copy will be mailed free upon addressing the manufacturer.

PROCEEDINGS OF THE I. R. E. for March, 1939, published by the Institute of Radio Engineers, contains several very outstanding articles, which include: Radio Progress During 1938, Lateral Disk Recording, Noise-Reduction Antenna, together with articles on Oscillograph Design, Constant-Frequency Oscillators, Strength of Atmospherics, U-H-F Measuring Assembly, Internal Impedance of Amplifiers, Electronic Motion in Tubes and Ionosphere Characteristics.

BAKELITE REVIEW for April, 1939, continues the very interesting discussion on the applications of this plastic material as used in various fields, including radio. This booklet, as always, contains many excellent photographs showing the many applications for this type of material and stresses the adaptability of plastics for various types of moulding. Copies may be had by writing to the Bakelite Corporation, 247 Park Avenue, New York City.

THE ELECTRIC FENCING HANDBOOK, published by The Electric Fencing Handbook Publishers, Muncie, Indiana, covers a complete resume of the various types of fences, together with an analysis of the correct applications for the installation of all types. The book contains a history of electric fencing with chapters on the use and benefits of electric fencing, Installation, Service and Care, Data on Commercial Fence Controllers, Safety Requirements, Laws, Regulations, etc., Applications of High Voltage Surges to Electric Fences, Bibliography and several other chapters covering a general discussion and description of electric fences together with precautions needed in the installation of this type of equipment. This book sells for \$1.00 and may be obtained from the publishers at P. O. Box 643, Muncie, Indiana.

PROCEEDINGS of the I.R.E., for January, 1939, contained many fine technical articles in the high-frequency and broadcast fields. Of particular interest to the station engineers is the manuscript written by John H. DeWitt, Jr., and Arthur C. Omberg on The Relation of the Carrying Capacity to the Accuracy of Portable Field-Intensity-Measuring Equipment. Other chapters include: Aeronautical Ground-Radio-Station Design, Observations on Sky-Wave Transmission on Frequencies above 40 Megacycles, Radio Interference, Line Equalization by Predistortion, Electron Beam Magnetrons, 56-Megacycle Reception via Sporadic-E-Layer Reflections, and Theory of the Electromagnetic Horn.

-30-

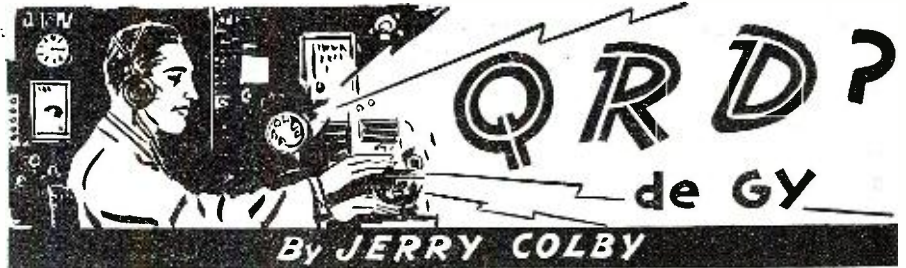

AT the New York Fair, RCA, in conjunction with the *N.York Tribune*, is publishing *The Radio Press*, a facsimile newspaper. This service will demonstrate the possibility of printing a news sheet in the average home by radio impulses. This all sounds swell. And ye ed is also one of the guys who can say "I-told-you-so." But where does the radiop fit into this picture? In spite of teletypes, Coxhead Vari-typers and radio facsimile scanning, transmission and reproduction devices, there must be some place where the radiop with his technical knowledge, previous training in handling messages, and generally conversant with the radio picture, should be able to find some niche into which he can fit. And I spoke to one radiop today who says he's been out of a job for eleven months!

SPEAKING of jobs, radiops on the West Coast are getting the breaks. Not only do they earn big money when on movie assignments for any one of the major studios, but they also get a chance to hobnob with motion picture personalities. Recently, three men were detailed for work with United Artists Studios for a sea picture. Then Hathaway and Al Putzker were billeted with Paramount Pictures. In the picture, *Ruler of the Seas*, they need a special effect . . . billowy clouds and a heavy sea. But for the last few weeks, whenever they'd find billowy clouds, the sea would be like a mill pond, and when they'd get a heavy sea, they'd find . . . Well, anyway, Hathaway sez he hopes for sunshine for another year and he'll make hay while the sun shines (that's puns for your coffee). \$20.10 for seven hours work (?) last Sunday couldn't be called exactly buttons, eh? Hoho for the life of a movie radiop! But they're complaining. They say listening to the Directors, Asst. Directors and Asst. Asst. Asst's., would drive a sane man sc...r...e...wy. Incidentally, Hath is W6CPG when he isn't taking pictures with the stars.

RADIOPS are always beefing for one cause or another reason but Haney, ZR2CP, holding down the key on the British vessel *SS Nils Molar* which was chartered by the Yamashita company, has a real squawk coming. The *Nils Molar*, which was anchored off Hangkow during all the recent shooting between the Japs and Chinese, couldn't go down the River Yangtze because the Chinese had sunk a couple of junks across the river. So the whole crew were commandeered to help bury the dead which were cluttering up the sidewalks in and around the city. Outside of being a nawsty job (ain't war Hell???) he'd like to know what are the regular union wages of grave diggers. Rawther cricket, what?

WHEN this story came to us we could get a mental picture of the old time slave markets where brawn and beauty were purchased by the highest bidder. A vessel of the Polish lines was tied up because of her radiop's hospitalization, causing a hurry call to be sent out to the various union halls for a couple of radiops, muy pronto. Well, Sir, the CTU-Mardiv, the ACA and the union headed by Frank Howe, formerly of the ARTA Local No. 2, competed with each other to place their men. When one organization offered its radiops for a certain price, the other organization underbid them, etc. We can't recall which association underbid the other, but instead of talking price, couldn't quality (technical knowledge and operating ability) be stressed? What price years of study, practice and experience?

WE understand the Alaska agreements are about to be signed by ARTA Local 7, San Pedro, California, which will take care of almost every man on the beach list today. Can you imagine a clean blackboard? It's good news, anyway.

TUNARADIOP SOLDADU had an interesting experience recently when he returned to the States via train after he had shipped out of San Diego on the *Tunaclipper Flying Cloud*. His pay was \$225 per month at sea, and \$125 per month if tied up to a dock for any reason. Well, after being at sea for a few weeks, without catching any fish, Soldau seems to have developed a case of stomach ulcers and took a health certificate of absence. From Guaymas to Diego is but a short trip of a few hundred miles, but Soldau had quite a time making it. He then waited for the *Flying Cloud* to return and upon its arrival he asked the skipper for his wages. But the Japanese said "no can do." So Soldau hired a sea lawyer, who made the skipper shell out. Incidentally, it is rumored that the *Flying Cloud* was one of the boats under surveillance by Navy Intelligence because it was suspected of being used by the Japs for everything else but fishing. And nothing happens around here!

TWAS pleasant indeed to hear from an old shipmate, J. C. Arenburg, now pounding brass on the *SS City of Alma* and who makes a few suggestions as to wanting a series of articles covering the various jobs in the radio field and diagrams of the usual xmters and recvrs found on board ship. Well, JC, we'll refer this to the Ed. and see what he thinks. Sure glad you like the new setup and don't forget we'll always be happy to get your angles. 73, OM.

WE also received a msg from one of our omnivorous readers who would like to know how he could get a job as an apprentice. He's perfectly right about waiting that as he can't get an apprentice berth, his ticket will run out and he won't be able to get it renewed unless he has some time to show on it. What to do. . . . No ships leaving port who can use an apprentice, no chance to break into the field! Well, Sir, how's to forget the floating field and get something on shore? Really, it's much safer and the competition isn't so keen. But, f'evens sake, don't try applying for an apprentice job without any pay a'tall.

A FEW more of those soft billets which come once-in-a-lifetime are the ones held down by CTU-Mardiv members J. G. Dwyer and J. L. Brannan. They are detailed aboard the landlocked yacht in the small lake of the Communications exhibit at the Fair. Their biggest job is to explain to the open-mouthed laymen the complexities of a radio installation. Also, CTU advises us that quite a few other members are handling the control boards which govern the distribution of radio broadcast to the networks and to the areas within the Fair. These men were loaned to the IBEW for the Fair's duration. And it'll last a year and more! Who sez there ain't no Sancyclause?

AND so, my hearties, another bit of scuttle-butt goes over the side and there's a bit of quiet on the battle-scarred front. We hear that Fred M. Howe, former secretary of Local 2, ARTA, was admitted to membership in the CTU-Mardiv and given the post of New York representative for that (More QRD? on page 47)



# Semi-Portable Volt-Ohmmeter

by R. K. WHEELER

Indianapolis, Ind.

***This unit, which is easy to construct, fills a need for a bench as well as a portable instrument. Fine for servicemen.***

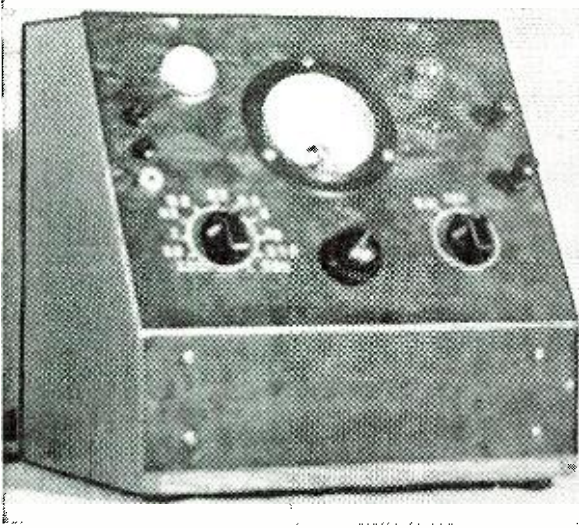

The sloping panel makes for ease in reading the unit.

It will hardly be denied that a primary requisite for radio work is a good volt-ohmmeter. The portable or "pocket" type of meter, owned by practically every radio man is a very useful instrument in its place, but has several disadvantages when used on the bench. Often the scale is too small for easy reading, and resistance ranges too limited on account of the low voltage supply. Such meters are frequently damaged when used on the bench, by being knocked off, or struck by dropped parts or tools. Then too, there is seldom any convenient place to set the meter when the bench is crowded, as it generally is.

An instrument of the semi-portable type avoids these drawbacks, without incurring the expense of a large permanent type of test panel, which often has disadvantages of its own. The instrument to be described is designated as *semi-portable*, as it is large enough to require a definite space on the bench, where it is likely to remain for long periods, but is light enough that it can be readily moved as occasion demands. The design is such as to permit the use of stock parts that any supply house should have on hand. A built-in power supply is included, so that resistances may be measured, from .5 ohm to 20 megohms, in four ranges, and with a condenser testing circuit employing a sensitive neon lamp installed as an added service.

When the scale of a milliammeter is calibrated for resistance readings, the center reading of the ohm-scale generally determines the amount of voltage required. A 1 mil meter with a half-scale reading of 4,500 ohms, thus requires a 4.5 volt supply for the standard range of 100 to 250,000 ohms. Higher ranges would therefore require voltage supplies of 45 and 450 volts, in order to use the same scale conveniently.

Since the zero adjuster should provide a variation of at least  $\pm 10\%$ , an additional 50 volts will be required,

which would make the total voltage around 500 volts. While such a voltage supply is not difficult to obtain, it is far simpler and more economical to use a meter with an ohm scale calibrated for use with a 3-volt battery. The Beede 0-1 mil meters can be obtained with such a scale, calibrated from .5 to 2,000 ohms, 30 ohms center scale. For higher ranges the user simply multiplies by 10, 100 or 1,000.

Since commercial ohmmeters often use a single condenser for filtering the rectified voltage, it may be thought that the amount of filtering shown in the diagram is unnecessary. In this case the primary purpose of the choke and input condenser is to afford a convenient way of adjusting the total voltage supply.

For ohmmeter service, a bleeder current of 10 to 12 milliamperes was found sufficient, so a stock transformer of the midget type was used. The transformer was rated at 325 volts at 40 mils, but with a light demand of about 12 mils, the DC voltage at the output was nearly 380 volts. In order to reduce the voltage to the 350 volts required across the bleeder and zero adjuster, different values of input condenser (shown as .5 mfd.) were installed, until the desired output was obtained. This adjustment should be made with the 10,000 zero adjuster set half-way on, and the power supply operating on normal line voltage.

The bleeder is best constructed by using a 25,000 ohm wire wound resistor, with sliders for obtaining 100 volts d.c. for the neon lamp, and 30 volts for resistance range R3. Three volts for R2 are obtained across the 250 ohm section, which is a single 1-watt wire wound unit. The voltage supply for the low ohm range was not quite so simply obtained.

Since the meter scale was calibrated for series measurement of resistors, the customary "back-up" or shunt method of measuring low resistances was not used, as direct readings were

desired. The center scale reading was 30 ohms, but the internal resistance of the meter was 50 ohms, so it was necessary to install a 75 ohm shunt in the R1 position of the switch, thus reducing the effective resistance to 30 ohms. The voltage required to swing the meter full scale is .05 volts, which was taken across the 5 ohm resistor in the bleeder. As different values of parts may be used by different constructors, the method of computing this resistance is detailed as follows: total resistance 30,000 ohms (bleeder 25,000— and one-half potentiometer 5,000) voltage 350 volts; current 11.667 milliamperes. Current at full scale, through the meter, 1 milliampere; through 75-ohm shunt, .667 milliampere; leaving 10 milliamperes to be passed through the 5 ohm bleeder section at .05 volts.

The neon lamp for condenser checking may be any size, and should be intended for 115 volt use. The  $\frac{1}{4}$  watt, T 4 $\frac{1}{2}$  lamp used is easily obtained, and has very good sensitivity, up to about 25 megohms, hence will give indications of condition of small mica condensers as low as .0001 mfd. It should be noted that series resistors are inserted in the 300-volt a.c. and d.c. lines in order to prevent damage to the lamp when the output posts are short-circuited.

The switch used in connection with the milliammeter should be of first-class construction, with as many positions as the user requires, such as the Yaxley #1321, 11-position switch which is very satisfactory for this service. The voltage and current ranges may be made anything the builder fancies, by varying the size of the multipliers and shunts.

The ranges shown, which are more or less standard, are 5-50-250 and 500 volts; 1-10-100 milliamperes. The resistance ranges are R1, .5 to 1,000 ohms; R2, 100 to 200,000 ohms; R3, 1,000 to 2 megohms; R4, 10,000 ohms to 20 megohms. It will be noted that

there is ample overlap in these ranges. The resistors used throughout as voltage multipliers were an insulated composition type having an accuracy of 2%. Any resistor of reliable make may be used, if better than 5% tolerance.

Although mechanical features of construction are usually subject to each individual's ideas the following pointers may be helpful. The panel may be made of 14 or 16 gauge aluminum, which is easily worked, and can be neatly marked by steel figure and letter punches. The panel can then be finished with black crackle lacquer, and the figures and letters filled in with white ink. The case is made of 3/4" white oak, which the writer obtained, cut to size, at a local lumber yard at a cost of 70c.

The sub-base can be conveniently made from a standard chassis pan about 10 x 6 x 2 1/2 inches. A portion of the top is cut away, leaving the sides extended. One-inch ears are bent at right angles at the extended sides, for fastening to the front panel. The slanting panel has much to recommend it, as the meter may be easily read by the operator when either standing or sitting.

If parts are selected and work done with reasonable care the finished instrument should have an accuracy better than the user can read. Small errors in the voltage supply and bleeder network are taken care of by the zero adjuster. Strictly speaking, the 250 ohm resistor in the bleeder should be 245 ohms, but in actual practice it was not found worthwhile to alter it.

Some objection may be made against the use of a 1 milliamperemeter, but if higher sensitivity is desired, a vacuum-tube voltmeter is the next logical step. If the constructor desires he can use a meter calibrated for a 4.5 volt battery. -30-

# ASIATIC S-W LOG FOR THE PACIFIC COAST

- 4.27 meg., RV15, Khabarovsk, U. S. S. R.; one of the oldest and most reliable short wave broadcasters in the world. Heard daily with fair volume from 11 p.m. to 1 a.m., and with excellent volume from 1 to 7 a.m.
- 6.00 meg., ?, Chungking, China; a new transmitter which may be heard regularly near 4 a.m. (news in English at 5:45). Exact identity still unknown.
- 6.08 meg., CRY9, Macao, Portuguese China; fair volume from 5:30 to 7 a.m. Monday, and 5:30 to 6:10 a.m. Wednesday.
- 6.13 meg., "Radio Saigon," Saigon, Indo-China; a super-powered new station, announcing in French and Chinese, and broadcasting from 4 to 6:15 a.m. daily. Reported in all parts of America with excellent volume.
- 6.19 meg., JLT, Tokyo, Japan; off the air during summer months, but will be used again this winter from 5 to 6:30 a.m., relaying Overseas Program of Broadcasting Corporation Japan.
- 6.72 meg., PMH, Bandoeng, Java; Old and reliable Dutch East Indies transmitter which broadcasts native music from 2:30 to 7:30 a.m., daily.
- 6.80 meg., ?, Khabarovsk, U. S. S. R.; a powerful Russian station uses this frequency near 5 or 6 a.m., irregularly.
- 6.95 meg., Kwei Yang, China; on the air with good volume from 3 to 7:15 a.m., daily. English announcements and news in English at 7 o'clock.
- 7.25 meg., JLG, Tokyo, Japan; off the air during summer months, but will be used again this winter from 5 to 6:30 a.m. relaying Overseas Program of Broadcasting Corporation Japan.
- 7.51 meg., JVP, Tokyo, Japan; off the air at present but will be used again within the next few months on several transmissions of the

- Japanese Overseas Program.
- 8.54 meg., RV15, Khabarovsk, U. S. S. R.; very strong harmonic of RV15 on this frequency. Sometimes as loud as the original 4.27 meg. wave near 5 a.m.
- 9.50 meg., KZRG, Manila, Philippine Is.; heard with fair volume from 11:15 to 11:45 p.m. and from 1 to 6 a.m., daily.
- 9.51 meg., VK3ME, Melbourne, Australia; good volume during 1 to 4 a.m., transmission daily.
- 9.53 meg., JZI, Tokyo, Japan; off the air at present, but will be used again this winter from 5 to 6:30 a.m., relaying Overseas Program of Broadcasting Corporation of Japan.
- 9.53 meg., ZBWZ, Hongkong, China; audible with excellent volume from 1 to 7 a.m., daily, to 8 a.m. Sat. announcements in English.
- 9.54 meg., VPD2, Suva, Fiji Islands; received with good volume during broadcast from 2:30 to 4 a.m., daily, except Sunday. Recorded programs and English announcements only.
- 9.55 meg., YDB, Sourabaya, Java; relays network programs from 2:30 to 7:30 a.m., daily, to 8 a.m. Friday, to 8:30 a.m. Saturday. No English announcements.
- 9.57 meg., KZRM, Manila, Philippines; heard with good volume from 1 to 7 a.m., daily and to 8 a.m. Saturday. Sometimes heterodyned badly by WJLK from 3:30 to 5 a.m.
- 9.58 meg., VLR, Melbourne, Australia; the most reliable and consistent Australian station available at the present time. Heard with excellent volume daily from 12:15 to 5:30 a.m., and on Saturday to 6 a.m.
- 9.59 meg., VK2ME, Sydney, Australia; heard with fair volume from 10 p.m. to midnight Saturday, and from 2 to 6 a.m., Sunday. Sometimes heterodyned slightly by VUD2 on morning broadcast.
- 9.59 meg., VUD2, Delhi, India; good volume from 4 to 7 a.m., daily. Still on the air, but gradually fades out after 7 o'clock.
- 9.62 meg., JFO, Taihoku, Formosa; received with fair signal strength from 5 to 7 a.m., irregularly. Usually gives news in English at 6 o'clock.
- 9.645 meg., JLT2, Tokyo, Japan; new station now carrying overseas programs from 1:30 to 2:30 p.m., daily.
- 9.69 meg., ZHP, Singapore, Straits Settlements; surprisingly good volume from 1:40 to 6:40 a.m., daily. English announcements and news in English at 5:30.
- 9.92 meg., JDY, Darien, Kwangtung; heard well from 3:45 to 5 a.m., daily, with occasional announcements in English at 4:45.
- 10.26 meg., PMN, Bandoeng, Java; relays programs of YDB (9.55 meg.) from 2:30 to 7:30 a.m. Sometimes returns to the air at 7:40 a.m. with program of native music.
- 10.53 meg., JIB, Taihoku, Formosa; usually on the air simultaneously with JFO (9.62 meg.) from 5 to 7 a.m., broadcasting news in English at 6 o'clock.
- 10.66 meg., JVN, Tokyo, Japan; formerly used to relay programs of Japanese National Network, but at present used only for phone work irregularly between 9 p.m. and 4 a.m.
- 11.00 meg., PLP, Bandoeng, Java; relays programs of YDB (9.55 meg.) from 2:30 to 7:30 a.m., and is usually the strongest of all Javanese

(Continued on page 49)

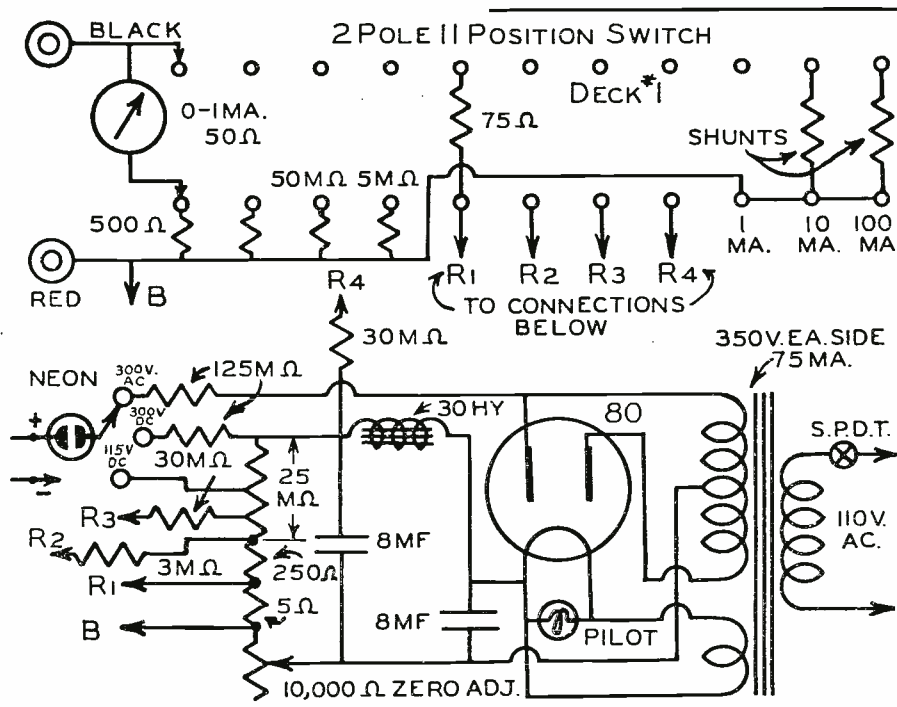



# SIGHT & SOUND NEWS

## SIGHT & SOUND NEWS TWO NEW TELEVISION BOOKLETS OUT

NEW YORK, N. Y. (Special to RADIO NEWS): Two informative booklets bearing the same title—"Television"—were issued recently. One is published by the National Broadcasting Company, the other by its parent firm—the Radio Corporation of America. Each booklet features a description of the new art.

The NBC booklet is designed for distribution on the television tour conducted at frequent intervals every day at Radio City. In text and illustration it supplements the guide's lecture and the demonstrations seen on the tour. Ten questions most frequently asked by visitors are listed together with answers. A list of "significant dates from television's diary" is also included.

Questions and answers form almost the entire contents of the RCA booklet. Here, too, by dates, outstanding television achievements of the past are listed. A glossary of television terms is an added feature.

## FACSIMILE DRAWS CROWDS

NEW YORK, N. Y. (Special to RADIO NEWS): Facsimile is drawing considerable attention at the New York World's Fair where RCA and Crosley are exhibiting their facsimile receivers.

Highlight of the RCA facsimile display is the publication of "The Radio Press," a daily radio-reproduced newspaper. It is issued under the editorial supervision of "The New York Herald Tribune."



Dr. P. C. Goldmark demonstrates CBS's synthetic reverberator to Hendricks.



It is hard to believe that television would make use of two tubes so far apart in size. A 6H6 compared to C-R.

## WALDORF-ASTORIA TO BE WIRED FOR TELEVISION

NEW YORK, N. Y. (Special to RADIO NEWS): With the installation of two television receivers in public rooms of the Waldorf-Astoria Hotel, New York, the management pointed out that, as far back as January 25, 1930, announcement was made that the entire 2,200 room hotel was being wired for television.

Some trade observers believe that the day is not far off when television will be featured in guest rooms of all leading hotels in the metropolitan area.

## OPPORTUNITIES OPEN UP IN TELEVISION

CINCINNATI, Ohio (Special to RADIO NEWS): Attractive opportunities await qualified persons on both the technical and talent side of television, according

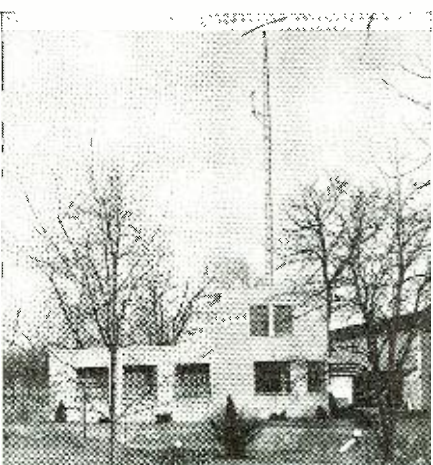

A wincharger tower installed for television purposes in Hatboro, Penn.

to James D. Shouse, vice-president of the Crosley Corporation, in charge of broadcasting.

"We will naturally have to feel our way when we do begin television broadcasting," Mr. Shouse said. "Meanwhile, we want to acquaint ourselves with those who can be called upon if and when their services are needed."

The point was made that, since television is an infant industry, without established precedents, a chance is offered to newcomers to grow up with the industry.

Crosley has leased the entire forty-eighth floor of the Carew Building, Cincinnati, for television studios. Considerable preliminary work has been done in preparing for video activity. Pending approval of a television broadcasting license Crosley engineers are conducting experiments with lighting and pick-up technique. It is interesting to note that the iconoscope camera in use was built by the firm's engineers in the laboratories of Station WLW.

## I. N. C. USES METALLURGY TO SOLVE TELEVISION PROBLEMS

UPPER MONTCLAIR, N. J. (Special to RADIO NEWS): Metallurgy's help in solving television problems is detailed in a statement by the International Nickel Company.

Based on experiments made in conjunction with the Allen B. DuMont Laboratories, the report, in part, points out that the metal parts of a cathode ray tube attain temperatures up to 1850° F. during bombardment.

"The bombardment," the report states, "serves to free metal parts of gases. The construction and assembly of the cathode ray tube calls for exceptional accuracy. The girls assembling the metal parts must do their work with great care and accuracy. The parts must be very accurately positioned and spaced, since such details affect the quality of finished tubes. Also, the metal parts must be imbedded in the glass, which again calls for



Fight fans watch a telecast of the recent Baer-Nova fight in New York.



great skill on the part of workers familiar with glass working. The cathode ray tube plant must have skilled glass applicators to take care of the more intricate details of glass working. Were it not for the availability of pure nickel and certain nickel alloys the cathode ray tube would not be a practical reality today."

The metals used in the tubes, according to the statement, must possess a number of mechanical, electrical and chemical characteristics.

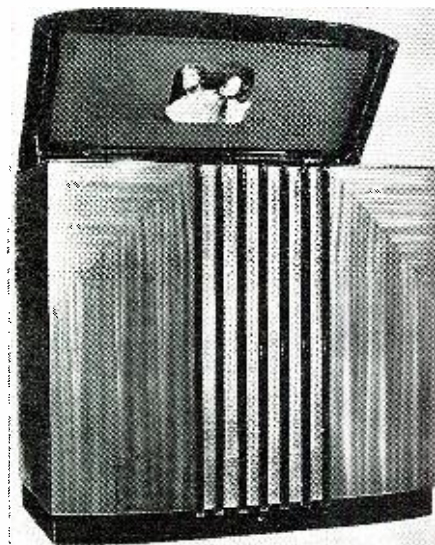

The General Electric Television Unit looks more like furniture than a set.

### NINE NEW TELEVISION TUBES ANNOUNCED BY RCA

CAMDEN, N. J. (Special to RADIO NEWS): The RCA Manufacturing Company has announced a line of nine television receiving tubes for renewal sale in television service areas. The line includes four kinescope picture tubes, three amplifier pentodes and two half-wave, high-vacuum rectifiers.

L. W. Teagarden, manager of the RCA tube division, declared that, while many of the tubes used in video receivers have been available to amateurs and experimenters for some time, only with the introduction of television to the public in New York have



Prexy Throckmorton congratulates the inspector on the 1st Tele-set.



At the control desk of CBS's W2XAX, are a group of their tele-engineers.

television receiver tubes become a consumer item. He added that markets in other areas will follow as additional video stations begin operation.

### NEW LIGHTING SYSTEM FOR RCA-NBC N. Y.

NEW YORK, N. Y. (Special to RADIO NEWS): The television studios of RCA-NBC Station W2XBS, New York are equipped with a new-type lighting system developed by William C. Eddy, NBC Video engineer.

Actually, the lighting system has been in use for some time but the network saw fit not to ballyhoo the development during patent negotiations, according to an NBC spokesman. Patent rights are held by RCA and it is anticipated that the lighting method may be adopted for movie studio work.

The system utilizes multiple units of six lamps each. The units may be raised, lowered and tilted by ropes and pulleys from a central control board. Thus, action can be continuous and lights can be altered without the need of prop men passing before the cameras. The lights can be pre-arranged in very short time, and, following a cued continuity, the lighting engineer can manipulate the units with speed and precision.

### INTRA-STORE TELEVISION NETWORK FOR NATIONAL ADVERTISERS

NEW YORK, N.Y.: A television network for department stores which will utilize the "tele-sales" sight-and-sound merchandising system to show shoppers the wares of national advertisers is being planned by the American Television Corp. The system was recently successfully demonstrated at Bloomingdale's in New York.

Ira A. Hirschmann, vice-president and sales director of Bloomingdale's said that this medium is the most important merchandising system to be offered to department stores in many years. Mr. Hirschmann remarked further that "the clarity and incisiveness with which merchandise is televised from our own studio and seen by customers on all floors simultaneously make the new medium a 'must' among selling methods."



RCA places the 1st television transmitter on sale. Price? \$100,000.00!

### ADJUSTABLE TELEVISION ANTENNA DESIGNED

NEW YORK, N. Y.: The Technical Appliance Corp., of 17 E. 16th Street, New York City, has designed an adjustable television antenna constructed of heavy duraluminum rods held together with a sturdy center insulator. The antenna is of the di-pole type and mounting straps are provided for attaching to an iron pipe or wooden mast. Precision adjustments are possible in both horizontal and vertical planes.

### TELEVISION OPENS NEW WORLD FOR TOTALLY DEAF

NEW YORK, N. Y.: Mrs. Evelyn Sass, national lip-reading champion in 1930, discovered during a visit to the General Electric television studio at the New York World's Fair that she was able to read the lips of the persons being televised. This is the first time that Mrs. Sass has been able to enjoy a broadcast.

It becomes apparent that if a telephone connection is accompanied by a televised picture Mrs. Sass will be able to understand because she will be able to read the lips of the person talking.

It is believed that this is an indication that television may open up an entirely new world of amusement and usefulness for the totally deaf.

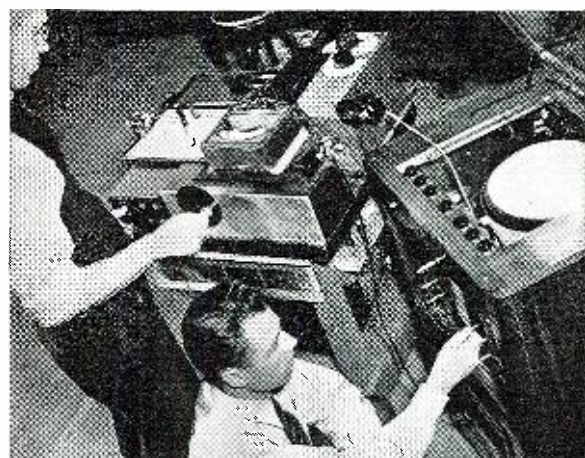

Factory inspectors for RCA give one of the home television receivers its final checks.



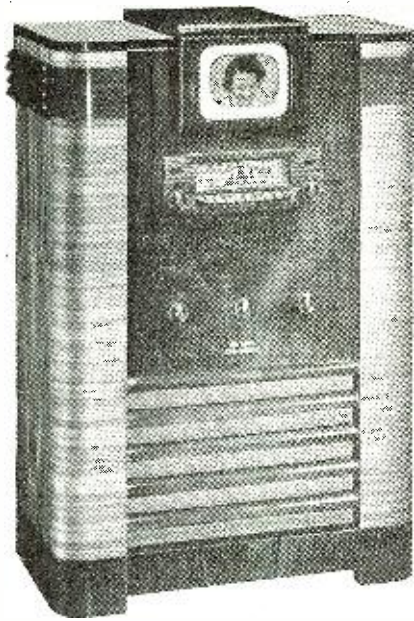

The new RCA-Victor Television Receiver Model TRK-5. It has 24 tubes.

## MAJOR BOWES PRESENTED WITH TELEVISION SET

PASSAIC, N. J.: The presentation of the latest television set was recently made to Major Bowes by Allen B. DuMont, president of the Allen B. DuMont Labs., Inc. The television gift is most opportune since the television transmitter of the Columbia Broadcasting System will soon be going on the air with its experimental programs and Major Bowes will want to follow and study this latest radio development.

## SERVICEMEN JAM TELEVISION MEETING

NEW YORK, N. Y.: Four hundred servicemen jammed the auditorium of



Dual transmitters installed at W2XVT for DuMont Labs., of Passaic, N. J.

the Electric & Gas Association of New York recently, while 150 others were unable to gain admittance to the series of meetings called by Allen B. DuMont Labs. of Passaic, N. J.

Dr. Goldsmith, head of the DuMont research activities, discussed general television principles and the present television broadcast situation.

Reception from a test transmitter, together with the effect of various control adjustments were among the  
(Continued on page 54)

# The VIDEO Reporter

by SAMUEL KAUFMAN

IT'S much too soon to even guess what historians will have to say about the New York World's Fair. But it's a safe bet that the exposition will be best remembered by future generations as American television's birthplace.

Previous video progress, of course, will not and should not be ignored. There were many years of laboratory achievements that preceded—and made possible—the sensational television displays that proved to be literal eye-openers at Grover Whalen's World of Tomorrow supershow.

The Fair came into the television picture in more than a figurative sense with the opening ceremonies being the subject of the first regularly-scheduled sight-and-sound transmission in the New York area. But you've already read about that. That, in itself, while important, is not the outstanding video phase of the exposition. The real television highlights—the features that will go down in the new art's history as epoch-making—are the radio manufacturers' displays which reveal not only how advanced television is today but also an idea of progress we can anticipate in subsequent seasons.

THE Radio Corporation of America, General Electric, Westinghouse and Crosley (the latter in conjunction with DuMont) are the television makers showing their video wares.

The RCA display is more inspiring than the others chiefly because it gives visitors a peek into future developments as well as demonstrations of current products. There is, for instance, big-screen television; this demonstration is similar to tests conducted before the Institute of Radio Engineers at a much earlier period, but its showing before Fair visitors is the first time the development can be viewed by the general public. Even more startling than big-screen television is the operation of a "flask" television set. And that's a thing we'll tell you more about.

Still bearing the label of "laboratory product," according to our special RCA guide, the "flask" unit produces a very brilliant image on a flat screen suspended in the bowl-shaped end of a huge cathode-ray tube. The design of the tube may be revolutionary. So's the price! Our guide said it costs \$600 to produce at this time. Hence we can see why it's still under the laboratory classification. At any rate, the tube is not on the laboratory shelf. At the Fair, it's out in the open where visitors can see it. And that may be a sign that the "flask" may be utilized in home television sets at an earlier date than anticipated.

The brilliance of the image is the most impressive part of the "flask" demonstration.

Although greenish in hue, the picture is a close approximation to home movies—a comparison television engineers themselves use as a standard.

Glass-sided receivers are not new. The idea of putting glass walls on sets for demonstration purposes goes back to early radio days. And, in television, too, many dealers use the idea for the sight-and-sound models they're trying to sell. But, at the Fair, RCA carries the transparent cabinet idea the limit by having an entire de luxe television console encased in glass and a molded plastic material which permits an X-ray view of the set from any angle. Anyone desiring chassis details needs but a glance at this transparent set and he'll "see through" the subject instantly.

A group of television sets receives the special World's Fair and dealer demonstration programs emanating from the RCA-NBC Empire State Building transmitter. At other times, films are transmitted over wires from a behind-the-scenes pick-up point in the building itself.

G.E. and Westinghouse feature television studios at their respective Fair buildings. Visitors are invited to step up and be televised while their friends look-in via receivers in other parts of the structures. Crosley, too, was planning such a setup but it wasn't in operation when the Video Reporter visited the firm's building. Only receivers were being demonstrated at the then incomplete display and a sign proclaimed that the showing was in conjunction with DuMont. The latter is the

New Jersey firm partly backed by Paramount Pictures.

WE had a chat with Gilbert Seides, CBS television program director, upon his return from a hasty survey of the British video scene. Seides is pursuing the policy of going steadily about his task of developing visual entertainment without any advance ballyhoo.

He did not seem enthused over the idea of a mobile television transmitter for Columbia's New York sight-and-sound station. Rather, he's favoring the adoption of the London method of building a permanent coaxial loop which would provide permanent pick-up facilities for Columbia—and NBC, too, for that matter—throughout the Times Square amusement sector.

However, it does seem that NBC will have a program edge on CBS until the latter has a relay station on wheels. It's the only means—under ordinary conditions—of picking up special event programs a considerable distance from the main transmitter. And

(Continued on page 55)



Harry R. Lubcke, Director of W6XAO's television station demonstrating one of the Don Lee Tele-Receivers.



# Photographing Your Radio

As told by **HENRY F. KROEGER, Jr.**

The Black Box, Chicago, Illinois

**Everyone has wanted to photograph their own equipment at one time or another. It is not difficult if they will but follow these rules.**

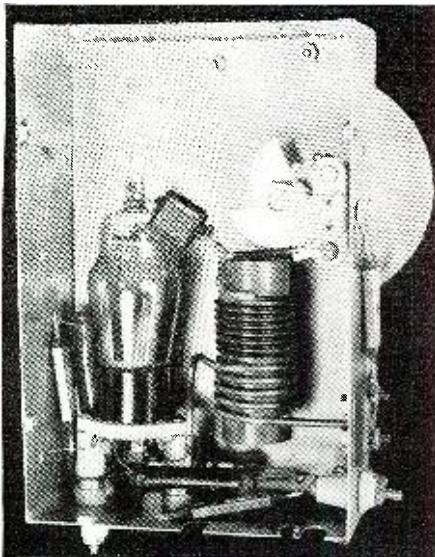

A good example of too long an exposure producing a washed out, glaring type of picture without many details.

**A**LMOST everyone who has dabbled in radio, either professionally or as a hobby, has wanted photographs of their equipment. Some have taken recourse to the professional picture-snapper, but many more have tried to get the film and paper to reproduce their many hours' efforts. There is nothing that fits better into the log book of the ham, nor the scrap-book of the experimenter than a picture of the rig or unit which he has built. It will bring back memories and may have scientific value when it will be needed most.

The serviceman, too, will want pictures of his equipment for future reference and also might even want to illustrate his advertising with interesting shots of his work.

Unfortunately, good photography and excellence in technical radio do not, as do ham and eggs, go hand in hand. Too often the expert in radio is but a greenhorn with the camera.

Now, good technical pictures can be

had, nor will you need an expensive plate camera that you have seen the professionals use. Any ordinary camera—yes, even the box *Brownie*,—will do a bangup job for you when it comes to recording that “brain-child” of yours. However, even as with radio, you will have to follow the rules, and while penalty for infringement of these set rules will not be dangerous, a high voltage shock to your person, the resulting picture may be a shock to your eyes, and look as little like the unit as does your favorite Aunt Fanny.

The rules are simple and they can be followed by even the most inexperienced. The first and most important is: **DO NOT TRY AND GET A LARGE PICTURE!** Get your unit *IN FOCUS*—sharp as a razor's edge—and rely on the commercial enlargers to make a large picture of your efforts. That is the fundamental secret of all pix-snappers. Even the most prolific professional will not try and do the impossible, and it is utterly useless to try to get a picture at once *IN FOCUS* and at the same time place the camera closer to the object than the camera's lens can stand. If you will but remember that rule, you will be well on the road towards making fine technical pictures.

This naturally raises the question, when is the camera in focus. With those cameras equipped with a ground glass—plate cameras, and the like—that is easy. They are in focus when the image on the ground glass is in focus. Do not confuse a ground glass with a “range finder” usually mounted on a swivel or into the front of the camera. If in doubt, ask your nearest camera or drug store.

Other cameras, notably the folding type, have scales engraved alongside the place where the bellows slide out. Use these, and a tape measure. Use the shortest distance set down, and measure to the *middle* of the set—not the front or back. That will enable you to get the average distance and the lens should take care of the balance.

With box cameras a distance of less than 5 feet should not be attempted. In fact a distance of 6 to 7 feet is far better. The picture will be smaller, but the image sharper.

The equipment that you will need is little, but you will need it all. There is not any compromise with this list. It is figured for taking pictures indoors, and, while on the subject, technical pix are best made away from the sun, since the lighting can be controlled.

Here is what you will need besides the unit to be photographed: One (1) clean white tablecloth, sheet or cardboard with rough finish. Your camera fully loaded with good medium “fast”

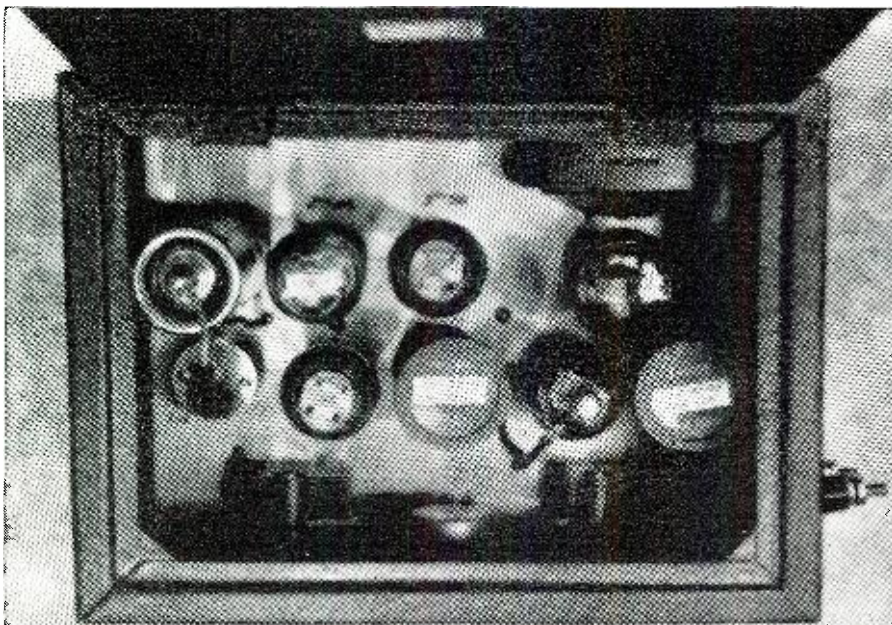

Here the exposure was correct and the lighting very good, but the camera was placed much too close to the unit, resulting in a blurred picture which has little scientific value. It needs a bit more distance.



# wn Radio Sets

film, two (2) No. 2 Photo-flood light and reflectors. One (1) table and a good clear wall. Also you could use a tripod or a chair or something solid on which to rest the camera. It must be supported by something other than your hands.

Do not spend a lot of money for reflectors unless you plan on taking a lot of pictures later. Buy the cardboard kind which are very cheap, and are usually given away free for the asking. Ordinary house sockets will do for lamp receptacles.

Next make your "set-up." Place the table against the wall. Stretch out the white paper or sheet on the table and tack some of the white paper or sheet on the wall for a background. This gives you a clean neutral tone and eliminates confusion on the background or base on which the unit is placed. Do your placing on the table not too close to the back wall, for if you do it will produce a conflicting shadow on the back wall, which is undesirable. The best position in which to place the radio is about three-quarters front—this eliminates a direct glare of light on its front. Also, this shows the depth of the rig, as well as the front.

If you want to show placement of parts in the rig, or a "look-down" photo, tip or block up the back of the rig with a prop of some sort—say a couple of books or blocks of wood—this raises the back of the set and you will be able to see into the rig with less confusion.

Set your camera on a tripod or something stationary, because for any exposure over a 25th of a second you are apt to get moved or blurred pictures with the camera being held in the hand. If your camera has a meter reading for distance, measure the distance with a tape measure to insure its being in sharp focus. If you have a ground glass in the back of the camera, focus on the ground glass.

Do not use a watch to count seconds. That is at once confusing and unnecessary. Do your counting as follows. Repeat in a slow voice the words, "One-thousand-and-one, one-thousand-and-two, one-thousand-and-three, etc., etc." Each time you say "one-thousand-and-seven, eight, nine, or whatever the number may be (depending on the number of seconds you are counting up to) you will mark the passing of one second. That is not only simple, but follows the professional procedure to a "T". Thus to count 15 seconds, you will have to count out loud to "one-thousand-and-fifteen" from "one-thousand-and-one."

In making technical pictures, never use the "bulb" position of the shutter, use the "time" one. This means that you will have to snap the shutter once

to open the iris and once again to shut it. It is between these two movements that you do your counting. Do not rush yourself. No picture was ever made without due and careful deliberation! The reason that you use the "time" and not the "bulb" as you might be inclined to do, is that if you "paint" the unit with light, as shall be explained right away, you will naturally tend to move the camera and a blurred picture will result. Once the camera lens has been opened, do not touch the camera except to close the lens, and do that carefully so as not to move the camera in so doing.

Now for the lighting. Take one light on a stand and locate it at the right or left of the lens, close to the camera. Then raise the light to just above the lens. This gives an even general flood of light, which is necessary. Use the other light while making the exposure, by swinging it in your hand over the front of the radio and on both sides as well as in an up and down movement. Keep it even with the camera. This is what we call "painting with light," and it eliminates all undesirable shadows. When "painting" the rig with the extra light, be sure not to get the light in front of the lens as this is apt to give a milky appearance or fogged film. "Painting" also forces light into the dark spaces, which is where it is needed, and it gives shape to the coils, transformers, tubes, etc.

The average exposure, when using Eastman Verichrome film, should be with two No. 2 Photo Flood lights and with the camera set as described above, and lens aperture set to about

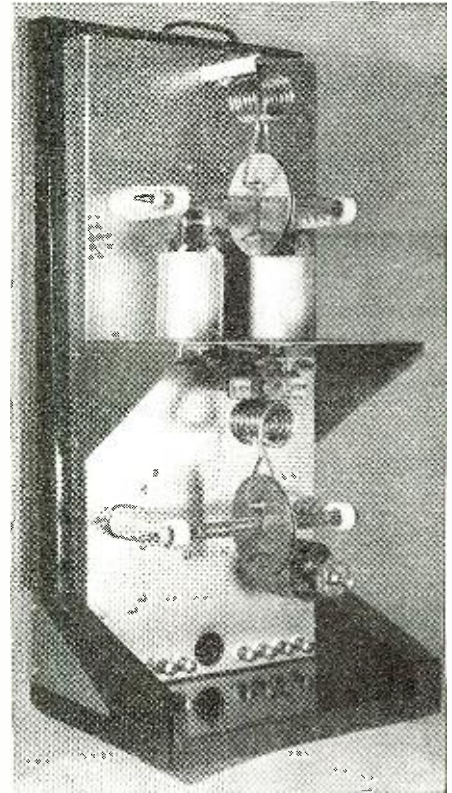

Excellent lighting and focus made a dramatic picture out of this usual radio transmitter. It has good detail.

*f* 11, the time should be about 15 sec.

Of course, if you are using a fixed focus camera such as a Brownie Box, or any such similar make, there will  
(Continued on page 50)

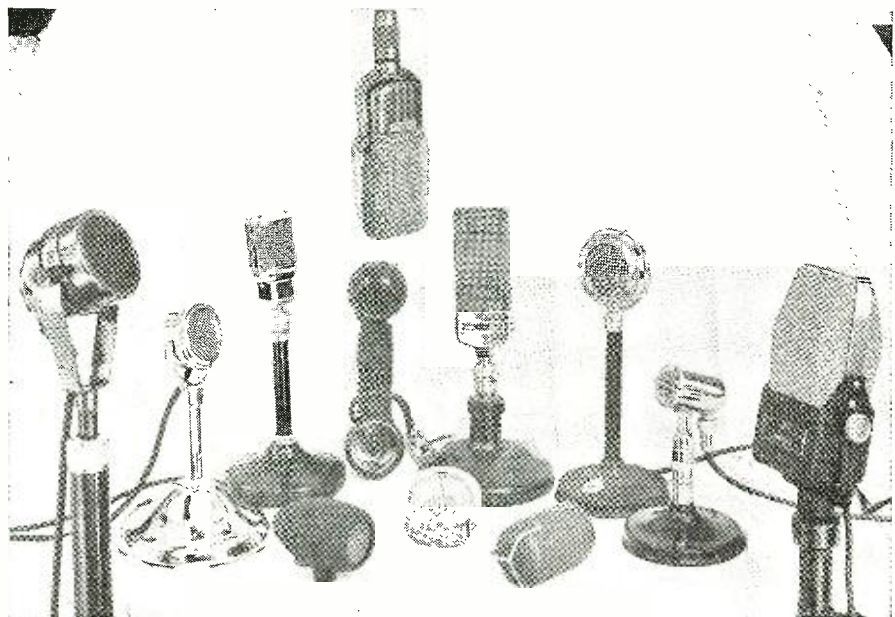

Good choice of background plus the correct focus and lighting made a fine technical photograph from a maze of microphones, many of which are of chrome nickel. The "snapper" followed all the simple rules herein.



# Service Manuals

by **ALFRED A. GHIRARDI, B.S., E.E.**

Author of "The Radio Physics Course," "Modern Radio Servicing"; member Radio Servicemen of America, New York Electrical Society, Institute of Radio Engineers.

Reprinted, with permission, from **RADIO Trouble Shooters Handbook**, Copyright, 1939, Radio & Technical Publishing Co. Copyright in Canada and Great Britain, and all countries subscribing to the Berne Convention, by Radio & Technical Publishing Co. All rights reserved.

## ATWATER KENT 37, 38 (Cont'd)

Noisy recep- . . . 1) loose nuts on power pack  
tion terminal strip  
2) defective volume control resistance strip

3) dirty volume control resistance strip and contacts (for Model 37 only). When installing new volume control strip, first connect it (in series with a 75-watt lamp) across the 110-volt line for about 1 minute. The heat produced will make the strip pliable so it can be inserted in the shell easily and without breakage

Hum . . . . . 1) often caused by loosened nuts on the grounded posts of the power pack terminal strip. This opens the filter condenser circuits. Tighten these nuts.

2) connect a 1-mfd. 400-volt filter condenser across the filter input that is between the '80 filament and ground  
No grid . . . . . 1) "open" grid-suppressor resistor (located on stators of the tuning condenser). May be replaced by any type resistor between about 500 and 1,000 ohms—800 ohms being about the usual best size

No grid voltage 1) check the antenna coupling choke  
on first r-f 2) check 1st r-f tube for an tubes internal "short" between the grid and other elements

"Choppy" or . . . 1) Test for "shorted" speaker filter condenser by detaching the green wire with the yellow tracer from the bottom terminal strip and connecting new 0.5-mfd. paper-dielectric condenser in series

2) noisy operation of volume control usually due to broken lead in r-f primary near the lug  
3) if trouble appears when condenser gang is rotated, dismount and clean the gang  
4) "steady" noise is frequently due to either or both of the cylindrical resistors in the power unit going bad

Oscillation . . . 1) faulty grid suppressors cause r-f squeals  
2) try new r-f and detector tubes. If oscillation persists fasten a thin brass, copper or aluminum shield about 1½ inches square between the first and second stage tuning condensers. Bend it in the form of an "L", bolting the narrow foot in place

## ATWATER KENT 40

Set "dead" . . . 1) open-circuited 625-ohm r-f and a-f bias resistance section and 2,200-ohm type '71A bias resistance section. Replace with new resistance units  
2) shorted r-f by-pass condenser  
3) check 0.3-mfd. speaker by-pass condenser  
4) fibre base of resistor under chassis warped, causing resistor element to "short" to ground. Slide a piece of fibre or stiff cardboard under unit to straighten it

Weak, or no . . . 1) fibre base of resistor under reception, chassis warped, causing resistor element to "short" to fading ground. Slide a piece of fibre or stiff cardboard under unit to straighten it

2) shorted speaker output condenser. Check plate voltage at '71A tube socket. If it is low, disconnect one speaker lead and plug analyzer test plug into '71A tube socket. If plate voltage is now normal, replace speaker output condenser

## ATWATER KENT 40—(Cont'd)

3) open-circuited detector plate resistor, or 1-mfd. plate by-pass condenser  
4) open-circuited first a-f resistor  
5) tuning belts loose  
6) defective glass tube grid leak resistor. Replace it with a carbon pigtail type resistor unit

7) filament voltage at '26 tubes low. Wire in two additional filament leads from power pack to filament lugs of first r-f tube socket. This will reduce the voltage drop in the filament line and raise the filament voltage on the '26 tubes. Especially effective when '26 tubes are old

8) connect a 1-mfd. 400-v. condenser between filament of 280 tube (where it connects to the first filter choke) and ground. Necessary to open the cans to do this. Also reduces hum

9) poor connection between flat-type antenna coil and its lug. Resolder connection

10) detector grid condenser short-circuiting to tuning condenser frame. Mount the condenser rigidly or wind tape around its free end  
11) receiver tuning circuits out of alignment. Realign circuits, installing a 3-gang trimmer across the tuning condenser sections for better alignment if necessary

Choked recep- 1) short-circuited or leaky tion. speaker output condenser

Distorted and 2) open-circuited detector plate weak resistor

Intermittent recep- 1) loose nuts on power pack tion terminal strip

2) volume control slider arm contact poor

3) antenna lead short-circuiting to shielding braid

R-f oscillation, 1) faulty grid suppressors squealing 2) try replacing r-f and detector tubes  
3) if oscillation persists, fasten a thin brass, copper, or aluminum shield about 1½ inches square between the first and second stage tuning condensers. Bend it in the form of an "L", bolting the narrow foot in place

Howl . . . . . 1) try a quick-heater type detector tube  
(during warm- 2) try reversing the blue and ing-up period) black wires on secondary of 1st a-f transformer  
3) shunt a 250,000-ohm resistor across the secondary of the first a-f transf.

Excessive hum.. 1) check for a poor joint between the "ground" terminal under the resistance strip in the power pack, and the wire which goes from this terminal through the insulating compound into the power pack

2) check for loose nuts on the power pack terminal strip  
3) extremely bad a-c hum may be caused by an "open" filter condenser. If it is the detector filter condenser, it may be checked by removing the yellow lead (which connects to the cable supply panel) and connecting a 1-mfd. condenser between this point on the panel and the center post (which is grounded)

Noisy reception. 1) defective or dirty volume control resistance strip. Clean with alcohol and adjust contact arm or replace unit. When installing new volume control strip, first connect it (in series with a 75-watt lamp) across the 110-volt line for about 1 minute. The heat produced will make the strip pliable so it can be inserted in the shell easily and without breakage

2) intermittently open-circuited 6,500-ohm detector plate resistor. Replace with new unit  
Noisy reception. 1) loose connection in r-f plate circuit between bias resistor with "crackling" and ground  
2) defective "flat" type wire-wound cathode. Replace tube

Noisy recep- 1) remove complete condenser tion while tuning gang assembly from chassis and wash in gasoline, cleaning all contact points

No grid volt- 1) check the antenna coupling age on first choke  
r-f tubes 2) check 1st r-f tube for an internal "short" between the grid and other elements

No grid volt- 1) "open" grid-suppressor resistor (located on stators of tuning condenser). May be replaced by any type resistor between about 500 and 1,000 ohms—800 ohms being about the usual best size  
Fading . . . . . 1) tighten all the nuts on both terminal boards in the power supply unit

## ATWATER KENT 41

Inoperative . . . 1) burnt-out tube  
2) open-circuited r-f line choke

Weak reception. 1) tuning belts loose

Broad tuning 2) tuning condensers not synchronized  
3) remove 1st r-f plate resistor (located near the tube and antenna coil) from circuit. Close the plate circuit after removing this resistor

Hum at res- 1) open-circuited r-f filament onance by-pass condenser

Noisy recep- 1) defective, or dirty, volume tion control resistance strip. Clean with alcohol and adjust contact arm—or replace unit. When installing a new volume control strip, first connect it (in series with a 75-watt lamp) across the 110-volt line for about 1 minute. The heat produced will make the strip pliable so it can be inserted in the shell easily and without breakage

## ATWATER KENT 42

Same Case Histories as those listed for Atwater Kent 37, 38 and 40

## ATWATER KENT 43

See also Case Histories listed for Atwater Kent 40

Inoperative. . . 1) open-circuited detector or first-audio resistor

Intermittent . . 1) broken voice-coil lead at soldered joint  
reception 2) loose nuts on power pack terminal strip

Weak reception. 1) antenna lead shorting to shielding braid  
2) tuning belts loose  
3) tuning condensers not synchronized

## ATWATER KENT 44, 45

Same Case Histories as those listed for Atwater Kent 40

## ATWATER KENT 46, 47

Same Case Histories as those listed for Atwater Kent 40, 43

## ATWATER KENT 51 D.C.

Same Case Histories as those listed for Atwater Kent 41

## ATWATER KENT 52

Same Case Histories as those listed for Atwater Kent 40

## ATWATER KENT 53

Same Case Histories as those listed for Atwater Kent 43

## ATWATER KENT 55, 55-C

See also Case Histories for Atwater Kent 67

"Dead" receiver 1) check screen voltage. If zero or below normal, check screen-grid by-pass condenser for short

2) if all receiver voltages check O.K., check speaker voice coil for open circuit. Check leads to voice coil for high-resistance joints  
3) "open" first or second a-f bias resistor  
4) check detector coupling resistor. Replace with 25,000 ohm resistor (value not critical)

Weak, distorted, 1) "open" detector biasing resistor choked recep- resistor connected between the detector cathode and ground. Value is 50,000 ohms—a metallized type replacement unit should be used

2) screen, by-pass condenser "open"

3) if grid-bias on output tube is high (or low), check two 9,500-ohm bias resistors across speaker field for open-circuit (or short-circuit)

4) second a-f bias resistor



# Case Histories

Continuing the popular series by Mr. Ghirardi. The reports show that the serviceman can use these case histories to cut his working time quite a bit.

- "open"  
 5) first r-f transformer primary "open"  
 6) receiver tuning circuits need aligning  
 7) if distortion occurs at low volume, replace the 750-ohm resistor biasing the 45's (it is yellow-white and located on top of the wire-wound resistor). Also replace both '27 tube biasing resistors. (For A.K. model 55 only)  
 8) examine joints in leads to voice coil for high-resistance. These joints are halfway between rim and apex of cone
- Intermittent ... 1) "open" secondary in second operation after being turned on a few minutes—reception gradually fading out completely with a buzzing sound

- Intermittent ... 1) "open" secondary of output operation, fading, intermittent noise  
 2) loose rivets on wire-wound resistors, especially bleeder No. 1 and the r-f and 1st a-f bias resistors. Squeeze rivets with pliers  
 3) poor connections at ends of various metallized-type resistors. Tug at resistors while ohmmeter is attached  
 4) poor connections at various tubular condensers. Check all joints

- Poor high frequency response 1) remove the "tone-quality" condenser connected across the plates of the type '45 tubes, located in the audio transformer assembly. (The condenser is located at the top of the can, which must be heated in order to remove it)

- Poor tone ..... 1) defective bias resistors  
 Audio "howl" ... 1) open-circuited 4-mfd. plate filter condenser in the a-f circuit (C14). Replace with a new unit

- Oscillation .... 1) screen by-pass condenser "open"  
 2) tuning condensers not properly aligned

- Motorboating ... 1) check all parts in detector and a-f stages, also all condensers. If they all check O.K., make a careful resistance check on all r-f chokes. A "short" of as little as a few ohms in one of them will cause this trouble.

- Noisy reception 1) dirty tube socket contacts  
 2) defective "local distance" switch  
 3) defective type '80 rectifier tube. Replace with new tube

## ATWATER KENT 56, 57

- Weak, ..... 1) no detector plate voltage. Distorted Check the resistor located under the cable template in the power pack. This resistor connects the two lugs on the end of the template where the cable joins it

- No grid ..... 1) open grid resistor (located on the stators of the variable voltage condensers). Replace with any type resistor around 800 ohms

## ATWATER KENT 60, 60C

See also Case Histories listed for Atwater Kent 67

- Inoperative .... 1) 1050-ohm flat wire-wound resistor under red and yellow resistor mounting "open." Replace with 1-watt carbon resistor

- Intermittent ... 1) see all troubles and remedies operation, fading, intermittent noise listed for Intermittent Operation & Fading for Atwater Kent 55, 55-C receivers

- Noisy reception, 1) drop in value of 40,000-ohm Low volume, 65,000-ohm a-f grid resistors. Replace with new units  
 Low plate voltage

- Noisy reception 1) see "Noisy reception" for Atwater Kent 40 receiver

- Distortion at ... 1) replace both '27 tube bias low volume resistors and the yellow-white 750-ohm resistor biasing the '45 tubes. The latter is located on top of the wire-wound resistors

- Intermittent re- 1) speaker voice coil "open." ception, (snapping the power switch off and on brings set back to normal)

- Weak or no ... 1) 1st or 2nd a-f tube bias signals resistors "open"  
 2) "open" primary in first r-f transformer

- Motorboating ... 1) check all parts in detector and a-f stages, also all condensers. If they all check O.K., make a careful resistance check on all r-f chokes. A "short" of as little as a few ohms in one of them will cause this trouble

- No screen ..... 1) "open" connection to volume voltage control slider  
 2) "open" volume control resistor

- Aligning ..... 1) "open" bleeder resistor see Case History note pertaining to this subject in Atwater Kent 55, 55-C listing

## ATWATER KENT 61-D.C.

See also Case Histories listed for Atwater Kent 67

- Noisy reception 1) filament resistor wound on iron strip overheats, burning the insulation and shorting to the iron. Replace with a tighter wound resistor

- No r-f plate ... 1) "open" primary in second or voltages third r-f transformer  
 No grid ..... 1) "open" secondary of one of the r-f transformers

- No screen ..... 1) "open" volume control voltages 2) "open" No. 1 screen grid resistor

- Noisy ..... 1) overheating of three filament (after several thousand hours of use) resistors wound on iron strips, causing their insulation to burn and shorting to the iron. Replace

## ATWATER KENT 67, 67C

- Fading, ..... 1) poorly soldered connections at leads of tubular condensers. Resolder connections

- Intermittent re- 2) poor contact between lugs ception and resistance wire in wire-wound resistors  
 3) poorly soldered connections to metallized resistors having solder ends. In all of the above cases test the connections with an ohmmeter, moving them mechanically during the test, and keeping the test prods on the terminals and not on the resistance element

- Volume control 1) check for an "open" in the unable to cut down strong local stations  
 2) try "shorting" the switch. If this cures trouble, open up switch and bend up the contact spring so it makes good contact

## ATWATER KENT 70, 72, 74, 75, 76

- Oscillation .... 1) worn dial rubber causes dial gear to pull gang condenser rotors out of alignment. Cut a rubber grommet in two, and place a metal washer on each side. Place on the round pin which is fastened to the large dial gear (placing it between the pointer control arm and the dial gear)

- Dial readings ... 1) three control-grid leads in in-off calibration correct positions. Rearrange them to run parallel

## ATWATER KENT 80

- Weak and dis- 1) open-circuited output tube torted, grid choke  
 Inoperative

- No control of ... 1) high-resistance connection volume between oscillator tube cathode prong and socket. Clean and tighten the socket prongs

- Poor sensitivity 1) defective type '24 AVC tube. Test by removing tube from socket and noting difference in volume. If the volume increases the tube is defective and requires replacement

- Hum, ..... 1) replace grid resistor in type Distortion '47 tube input circuit

- (not due to 2) replace the detector plate condensers or resistors) coupling condenser

- Intermittent re- 1) high-resistance short-circuits ception between tube socket holes, caused by solder from tube prongs being rubbed on to tube sockets while twisting tubes on socket when locating correct prong holes. Rub pencil craser on top of tube sockets to clean away any solder and thus remove shorts

- Intermittent ... 1) replace resistor from grid of whistle near '27 oscillator tube to ground with one of 50,000-ohms  
 700 kc.

- Noisy volume ... 1) raise the end of the contact control with long-nose pliers and bend it in toward the winding slightly. Then clean the resistance strip with alcohol

## ATWATER KENT 82

See also Case Histories listed for Atwater Kent 80

- Oscillation .... 1) replace AVC plate by-pass (steady) condenser with new 1/4- or 1/2-mfd. unit

- Intermittent ... 1) check screen by-pass cond. reception Replace if necessary

- Motorboating ... 1) 0.25-mfd. detector plate filter (when volume control is set at low-volume position) condenser "open" (connected from detector plate to ground)

- Oscillation cut- 1) locate the i-f stage plate ting in and out of signals trimmer condenser. (This is one of two trimmers located on top of the i-f transformer, completely enclosed in shield con.)

- Check the mica of this condenser for carbonization or deterioration, resulting in electrical leakage

- Replacing ..... 1) be careful when replacing volume control the volume control to leave in the circuit the bleeder resistor from the volume control to ground, and one from the other end of the volume control to the screen-grid terminal of the AVC tube. As these are concealed in the leads connecting these points, they will be left out of the circuit if the leads are changed

- Noise when ... 1) coil shield over i-f transf. chassis is loose. Tighten all shields tapped

## ATWATER KENT 82F

- Replacing ..... 1) see the Case History data volume control listed for this under Atwater Kent 82

## ATWATER KENT 83

- Intermittent ... 1) replace resistor from grid of whistle near '27 oscillator tube to ground with one of 50,000-ohms  
 700 kc.

- Poor tone, low 1) r-f choke in the pentode control-grid circuit "open." (It response when tone control is set at "bass" position connects to one of the leads to the tone control switch.) A permanent repair may be effected by shorting out this choke as apparently it has no important function in the circuit. This trouble may not be revealed by a set analyzer

- Aligning data ... 1) as the alignment trimmers are located inside the coil shields, and the alignment should not be carried on with the coil shields off, either drill holes in the shields to give access for the aligning tool—or use duplicate shields with appropriate holes drilled in the top to permit adjustment

## ATWATER KENT 84 (EARLY MODEL)

- Inoperative ... 1) open-circuited type '24A first detector plate choke due to corrosion at the terminals. Resolder leads at terminals

- 2) internally open-circuited plate coupling and i-f selecting choke in the grid lead of the type '24A i-f tube (value 66-ohms). Replace with a new unit

- 3) "open" 130-ohm antenna choke

- 4) increase in value of 40,000-ohm bias resistor in the oscillator circuit. Replace with new unit

- 5) often necessary to replace 78-ohm i-f transformer primary

- 6) re-align receiver after these changes

- Noisy reception 1) corroded tuning condenser contacts

(Continued on page 48)



# SHORT WAVE FLASHES

BY CHARLES A. MORRISON  
and JOHN D. CLARK

By Charles A. Morrison

Frequency in megacycles Time in Eastern Standard

## Special Good-Will Programs

**TUESDAY**, July 11, from 6:30 to 7 p.m. EST, and Wednesday, July 12, from 9 to 9:30 a.m. EST, Golden Gate International DX Festival Broadcasts, over W6XBE, on 15.33, and 9.53 mcs., respectively. Sunday, August 20, from 1 to 3:30 a.m. EST, over TGWA (9.685), TGWB (6.49) and TGWC (2.32), all of Guatemala City, Guatemala.

## New Rules Regulating International Stations Adopted

New regulations for international broadcast stations which may have far reaching consequences have just been issued by the Federal Communications Commission. One provision allows these stations to include commercial or sponsored programs, under certain restrictions. The rules further state that licensees of international broadcast stations "shall render only an international broadcast service which will reflect the culture of this country and which will promote international goodwill, understanding and cooperation."

Short-wave stations licensed as experimental are to be classified into three separate groups.

## New Short Wave Stations (On the Air)

**CHINA**—Ashley Walcott of San Francisco, California, reports XGOK (11.81), Canton, relaying a station of the same call daily from 5:30 to 8:40 a.m. EST. All transmissions are under Japanese auspices. A program announced by a woman in English is presented daily from 8 a.m., with news in English at 8:20 a.m. EST. XPSB (7.69), an optional frequency for XPSA of Kweichow Province, broadcasts irregularly. Unidentified Chinese stations have been reported as follows: on 11.74, at 6:20 a.m.; on 11.72, at 6 a.m. and on 11.65, at 12:05 a.m. EST.

**COSTA RICA**—According to an official list, T17RVM (6.035) of Las Juntas, is broadcasting irregularly with a power of 500 watts.

**ENGLAND**—The BBC has introduced a new series of calls for assignment as new Daventry frequencies are put into use. Three of the new series, which will run from GRZ to GRA, have already been assigned, namely, GRZ (21.64), GRY (9.6) and GRX (9.69). GRX broadcasts daily from 12:25 to 4 and from 4:20 to 6 p.m. EST. The other two frequencies are not in use at present.

**FRENCH INDO-CHINA**—"Radio Volonte Indochinoise," at 15 Boulevard Rolandes, Hanoi, is operating on 7.1, daily from midnight to 2 a.m. EST. The station is a low power one and has not been reported heard in North America as yet.

**JAPAN**—The new transmitter which is being put into service for the daily relays of JOAK for reception in Manchukuo is operating under the following calls and frequencies: JVV (7.257), JVV2 (9.675), JVV3 (11.725), JVV4 (15.235) and JVV5 (17.825). As soon as the new frequencies are formally put into service the old transmitter with calls JVH, JVN, JVM, JVT, etc., will be retired from operation.

**MANCHOUKUO**—A new 20,000 watt short-wave broadcasting station to be used for overseas broadcasts is nearing completion at Shinkyo. It will operate under the call MTCY on the following frequencies: 6.125, 9.545, 11.775, 13.53 and 15.2. Ashley Walcott of San Francisco, California, heard the new station testing on the last two named

frequencies, one morning between 4 and 5 a.m. EST.

**NEWFOUNDLAND**—VONG (5.73 and 5.98), operated by the Avalon Telephone Company at Mount Pearl, near St. John's relays VONF (640 kcs.), daily from 8:30 a.m. to 12:30; and from 1:30 to 9:30 p.m. EST. NBC-type chimes are used half-hourly as an interval signal. Reports on reception should be sent to the Broadcasting Corporation of Newfoundland, Newfoundland Hotel, St. John's.

**REUNION**—"Radio St. Denis" (9.6), located at St. Denis, and operated by the Government Department of Posts, Telegraph and Telephones, broadcasts irregularly with a power of 60 watts.

**ROUMANIA**—The Newark News Radio Club reports a station operated by Polytechnic College of Bucharest, is being heard daily from 2 to 3 p.m., on a frequency of 12.21. Announcements are in English, French, etc.

**SUNDAY ISLAND**—ZMEF (9.2), contacts ZIL5 at Wellington, New Zealand, frequently from 1:45 and 2:15 a.m.

**SWITZERLAND**—The new government transmitter at Schwarzenburg, first heard on May 15, by J. Pedersen of Bridgeport, Conn., is testing Monday nights from 6:45 to 8:15 p.m., in parallel with the Prangins transmitters HBO (11.402) and HBJ (14.535).

**SYRIA**—Alfred Tuff of London, England, states there is a new short-wave station at Aleppo, operating on a frequency of 12.215 mcs.

## Under Construction

**MOROCCO**—According to the International Bureau of Telecommunications at Berne, Switzerland, a new 15,000 watt short-wave station, which will operate on 8.185 and 11.94, is now under construction at Rabat. The new station will be known as "Radio Maroc III".

## Notes of Interest

**AUSTRALIA**—VLR (9.58), Melbourne, is being heard throughout the United States with loud signals up until signoff, weekdays at 8:30 a.m. and Sundays at 7:30 a.m.

**BOHEMIA**—OLR4A (11.84), Prague, the only frequency in use at present, is on nightly with the transmission for North America, starting at approximately 6:45 p.m.

**COSTA RICA**—Alfred Tuff of London, England, states TI4NRH (9.692), Heredia, broadcasts on Sundays to 9 a.m.

**CUBA**—R. Rubio of Havana, Cuba, advises me that COCA is now using the slogan "de los grandes Almacenes El Telar"; COCE the slogan "La Voz del Transporte," and COCV, the slogan "de los Almacenes de Panos La Borla." COX, operated by the Cultural Department of the Cuban Army is testing almost daily from 4 to 6 p.m. on a frequency of 6.39. Reports are requested and should be sent to the Cuerpo de Senales, Ciudad Militar, Habana, Cuba. International Reply coupons are unnecessary.

**D.R.**—John Oskay of New Brunswick, N. Y. suggests that the best time to log Dominican stations is Saturdays between 5 and 9 p.m. since most of them are broadcasting during this period.

**ETHIOPIA** (I.E.A.)—H. Clein of Los Angeles, Calif., is mystified by the fact that a report of reception sent to IABA (9.65) in Addis Ababa, brought a prompt reply verifying reception of IBC, "Radio Addis Ababa." IBC is listed in most sources as a commercial station at Rome.

**FRANCE**—Charles Guilbert of Paris, France, advises that the power of "Paris Mondial," is to be increased immediately.

**GUATEMALA**—TGWC (2.32) of Guate-

mala City, Guatemala, is heard with good signal strength in the United States when not QRM'ed by CYQ (2.318) of Toronto, Ontario. TGXI (6.132) is being heard early mornings only.

**HUNGARY**—Roger Legge of Binghamton, N. Y., reports hearing HAAQ2 (7.221), an experimental transmitter at Budapest, frequently between 9:30 and 11:30 p.m.

**JAPAN**—The new Tokio transmitter JVV3 (11.725), is being heard frequently after 12 midnight in parallel with JVH (14.6), relaying baseball games, and replacing JVN (10.66) in the 4 to 7:30 a.m. transmission to Manchukuo.

**NEW CALEDONIA**—FK8AA (6.122) at Noumea, heard Wednesdays and Saturdays, from 2:30 to 3:30 a.m., is believed to have increased its power.

**NICARAGUA**—YN3DG, Estacion Radio-difusora "Gilfillan" of Leon, Nicaragua, normally operating on a frequency of 7.128, has an optional crystal for 13.9, which is used occasionally for special dx broadcasts to escape the QRM usually prevalent on the lower frequency. John Larsen of Geneva, New York, reports an unidentified Managua station on 5.845, heard broadcasting to 11 p.m.

**POLAND**—SPW (13.635), Warsaw, is being heard with loud signals now on its nightly broadcast from 6 to 9 p.m.

**PUERTO RICO**—WVKAQ, broadcast band station in San Juan, has received permission to rebroadcast sustaining programs received from short-wave stations W2XE and W3XAU on a temporary basis.

**SPAIN**—Lee Mason of Detroit, Michigan, states that EAQ (9.86), Madrid, is on the air again nightly from 7:30 to 8:30 p.m. with a broadcast for North America. The station is identified now as Radio Nationalist Spain, EAQ Madrid, and transmissions are terminated with "Franco, Franco, Franco, Viva Espana." The announcer requests reports and promises they will be verified promptly.

**TURKEY**—A letter from TAP (9.46), states the C.W. station that has been QRM'ing it is a commercial telegraph station in New Jersey and that steps are being taken to do away with this nuisance so that listeners in the United States can enjoy the programs free from interference.

**U.S.A.**—The request of the Pillar of Fire Organization of Zarephath, N. J. for an international station to operate on 6.08, 11.83 and 17.83, has been denied by the F.C.C. Perry Ferrell of Linwood, N. J., reports reception of WGLN (4.14), the crash boat for the "Yankee Clipper," testing with station WGLM. In preparation for its annual trip to the Arctic Northland, Donald Ellas Clark of the schooner "Effie M. Morrisey," has requested a permit to operate a short-wave station with a power of 100 watts, on 6.425, 8.655, 9.135, 12.862 and 17.31 aboard the vessel.

**U.S.S.R.**—The unidentified Soviet transmitter on 15.41, is frequently heard near 6 a.m.

**VENEZUELA**—HJ2BAC (4.815), has a decided harmonic on 9.63 mcs.

## Special Transmissions of Interest

**Daily**—from 6:30 to 7 p.m., news in English, over HP5A (11.7) of Panama City, Panama; 7:30 p.m., news in English, over HAT4 (9.125) of Budapest, Hungary.

**Weekdays**—from 4 to 4:30 p.m., CBS news broadcasts in French, German and Italian, over W2XE (17.83).

**Mondays**—at 7:30 p.m., "The Bulletin for Dancers," presented by Edward Ayzavian, over W1XAL (6.04) or W1XAR (11.73) of Boston, Mass.

**Tuesdays**—from 12:30 to 1:30 p.m., relay of broadcast of "Radio-Algiers" to Tunisia and the Near East, over TP2Z (8.96) of Algiers, Algeria . . . at 3:30 p.m., "The Cabinet Series," over W2XAD (15.33) and W2XAF (9.53) of Schenectady, N. Y.

**Fridays**—from 4 to 5:45 p.m., over LSX (10.35) of Buenos Aires, Argentina.

## Revised Schedules

**AUSTRALIA**—VK2ME (9.59), Sydney, broadcasts Sundays from 12 mid. to 2, from 5 to 9 and from 11:30 a.m. to 1:30 p.m.

**ENGLAND**—The complete schedule of Daventry broadcasts is as follows: Trans. 1, from 12 midnight to 2:15 a.m., over GSI (15.26), GSD (11.75), and GSB (9.51); Trans. 2, from 5:45 to 8:50 a.m., over GSJ

(More DX notes on page 62)



### JUST GLANCE OVER THIS PARTIAL LIST OF CONTENTS

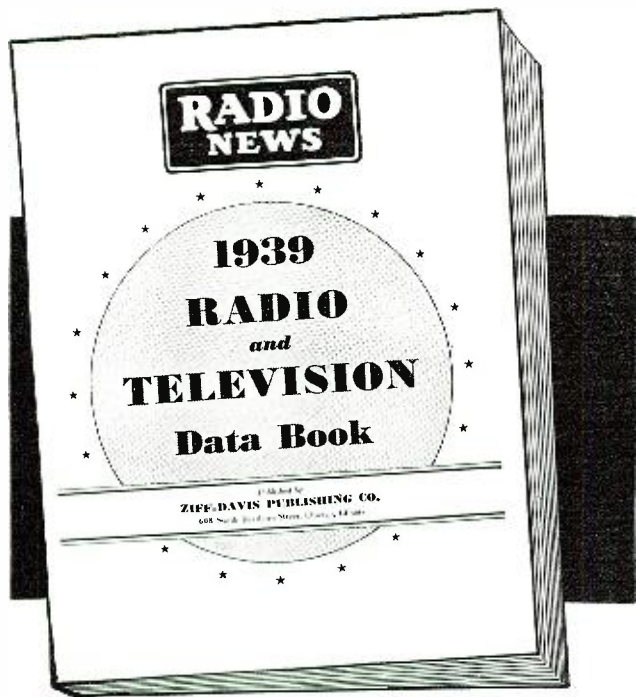

● TELEVISION

Television Occupations of the Future  
Television Words and Terms  
Building a Television Receiver

● RECEIVER SECTION

The Jones 8 Tube Superhet.  
Radio Tuner for P.A. Systems

● TRANSMITTER SECTION

Visual Deviation Meter  
20-watt Bandwidth Transmitter  
U. S. Government Amateur Radio Regulations

● INSTRUMENTS

An Electric Calibrator  
Home-Built Audio Oscillator  
A Vacuum Tube Volt-meter

● GENERAL SECTION

Wire Table—Winding Turns per inch  
Building a Radio Treasure Hunter  
International "Q" Signals

● EXPERIMENTER SECTION

Dual Diversity Coupler  
Constructing a Polarized Relay  
Home-made Scratch Filter  
Single Tube Announcer

● SERVICEMEN'S SECTION

Service Problems with Interference  
How to Advertise Your Shop  
Handy File System  
Measuring Power Output  
Servicing A.F.C. Systems  
Tips on Radio Noises

● AMPLIFIER SECTION

An AC-DC 4-watt Amplifier  
A Scotchman's Special Amplifier  
Making Your Own Records  
DB 2-4000 ohm Conversion Chart

● GADGET SECTION

Home-made Pilot Light Socket  
Meter Kinks  
Increase Voltmeter Utility  
Fish-pole Antenna  
Plugin Resistors  
Projection Device for CR-913 Tubes

Numerous illustrations, charts, hook ups and diagrams. Many different items and articles, giving complete radio coverage. A wealth of invaluable radio information. Actual size, 8"x11".

# FREE

## RADIO NEWS 1939

### Radio and Television Data Book

**FOR THE  
SERVICEMAN  
EXPERIMENTER  
AMATEUR**

You can obtain this great book *absolutely free of charge!* Fill out and return the coupon with your remittance of \$1 for 12 issues of RADIO NEWS, and we will rush a copy to you without any additional cost! If you are already a subscriber and want this book, mail the order blank with your remittance and your present subscription will be extended. Act now—our supply of these valuable books is limited!

**Radio News, Dept. 89D  
608 S. Dearborn St. Chicago, Ill.**

Enclosed find \$1. Send me the next 12 issues of RADIO NEWS and rush a copy of the 1939 RADIO DATA BOOK to me without charge. (If renewal, check here )

Name .....

Address .....

City ..... State.....

Please describe your occupation: .....



## NATION'S CAPITOL ADOPTS RADIO-EQUIPT POLICE MOTORCYCLES

**W**ITH recent local outbreaks of crime challenging every resource of law enforcement agencies, the Police Department of the District of Columbia has equipped a fleet of 50 motorcycles with radio receiving sets. In use by traffic officers, these radio-outfitted "motor-bikes" will augment the existing wireless facilities of cruising police cars in combating crime.

These radio-equipped motorcycles will not only prove to be an aid to the solution of traffic problems, it is claimed, but will also provide police officers of the Nation's capital with a valuable weapon with which to outwit the lawbreaker.

One of the advantages to be gained by use of the radio receiving sets for motor patrol is that the officer does not have to telephone to the precinct for news of the location of fires. This information will be broadcast directly from the station to which the receiver is adjusted.

In event of holdups the patrolman in that precinct can pick up the call and race quickly to the scene of the crime. The motorcycle can attain greater emergency speed in city traffic than police cars. Traffic jams can be dispersed and the motorcycle patrolman employed to augment the police corps in cruiser and squad cars.

Traffic violations have been reduced in cities using radio-equipped motorcycles. Accident reports incidental to

reckless driving also have shown an appreciable decline.

The radio receiver consists of two units, mounted astride the rear wheel of the motorcycle, and resembles a pair of oblong saddlebags. Each unit is mounted in rubber to eliminate vibration, and housed in a waterproof steel box, which measures 20 inches wide, 18 inches long and 8 inches high. These units are protected by a carrier of circular steel tubing which is practically shock resistant.

The receiving set is a sensitive superheterodyne using five tubes and can be tuned to operate on any frequency assigned to the police service, usually around 2400 kilocycles. The outfit is so selective that it will get only police flashes, and stations bordering on police frequencies will not interfere with reception from the station to which the receiver is adjusted. While as yet the motor patrol have no call numbers, it is likely that the first figure of the call number will be the number of the police precinct. Thus, the 8th precinct radio call numbers will be as follows: 81, 82, 83, etc.

The current required to operate the receiving set is supplied by the motorcycle storage battery. While the total electricity is slightly over two amperes, or less than is required for an ordinary 32-candlepower bulb, the generator is especially built and of the "heavy duty" type. The speaker is somewhat like a

regular spotlight and is mounted on the handlebars of the motorcycle. It has been built with highly directional facilities and will throw the signal in the direction of the rider. The antenna is of the plate type, protected by rubber insulators and suspended beneath the motorcycle frame where it is hidden from view. The radio receiving set is built so that each part is easily accessible for repairs and the entire radio chassis is anchored to the frame of the motorcycle in such a way that it can be moved by simply pulling out a cable plug and taking out a few bolts. The weight of the radio outfit is about 35 pounds and the cost, installed, is approximately \$150.00.

While the police motorcycle departments of Washington and Milwaukee are the only cities to be completely equipped with radio receiving sets, many of the leading cities of the United States and Canada have been experimenting with this equipment. Among them are: Chicago, San Francisco, Augusta, Georgia; El Paso, Texas; and Vancouver in British Columbia and Ottawa in Ontario, Canada. [*The Nassau County Police (N. Y. State) have been equipped with radio motorcycles since 1936*—Ed.]

One manufacturer of motorcycles shows a picture of a traffic officer astride a radio-equipped "motor-bike" with this reassuring caption: "Death retreats where he patrols." —50—

## VERMONT FARMER RADIOIZES HIS FARM AND NEIGHBORS' HOUSES

**M**'USIC while he works. That's the pet hobby of Mr. H. O. Van Vliet, a farmer of East Charlotte, Vermont, on whose large farm one may hear philharmonic orchestras and concert ensembles from early morning until late at night. Van Vliet has installed radio speakers in practically every building on the farm, all of which are controlled from a master speaker set in his house.

It all started because Van Vliet, a busy and industrious farmer, is ardently fond of classical music. Without batting an eye, he can tell you the names of all the major symphony orchestras, conductors, principal soloists and the works of the various classical composers. But because he had cows to

milk, fields to plow, wood to chop and other barn labors to perform, he missed many of his favorite programs.

So he set about remedying that situation. He bought several old speakers for a couple of dollars each. Using extension cord, he set up a speaker in the woodshed, another in the cow barn, one in the chicken house and still another in the large horse barn.

To these he added three in his house; one in the bedroom, a large cabinet speaker in the living-room and another in his kitchen. The entire layout didn't cost over \$12.00.

He still has one problem unsolved: he can't find a station broadcasting classical music at 5 a. m., the hour when

he hitches his suspenders and starts out for the barn to milk the cows. The radio minded farmer complains that he has to "spend an hour or two in the barn the first thing in the morning and all I can get on that consarn radio is jazz music from Boston."

Asked if music helps the chickens to lay more eggs and his cows to give more milk, Van Vliet replied, "I know definitely that animals like music. When I turn on some soft, pleasing music out in the farm buildings, the hens and cows respond to it immediately. They quiet down and seem to enjoy it just as much as I do."

Farmer Van Vliet is also the radio godfather of the village of East Charlotte. This typical Vermont ham-

let of only a dozen homes and one general store, nestles on a back road in the hills; quiet, quaint and oblivious of the rush and excitement of the world.

But Mr. Van Vliet furnishes radio entertainment, not only to his livestock in the barns, but to any neighbors who may care for it.

In the living room of his homestead are four radio receivers; One five tube, battery type; one eight tube all-wave receiver; an eleven tube receiver and the fourth a receiver of ancient vintage and of unknown make or origin. These he purchased second-hand for less than \$10 each.

The entertainment received on these sets is fed through an ingenious, home-made "switchboard" consisting of a piece of rubber matting about eight inches square, with several rows of slits through which small loops of wire have been fastened to their respective transmission lines to "remote" points.

By clipping the output of the various receivers to certain combinations of loops on the switchboard (known only by Van Vliet) the program may be fed to the remote points which are located throughout the village.

He has a line running from his living room to the home of the village Minister; two other neighbors have had his "remote" lines running into their homes and with speakers attached in these various homes, Van Vliet furnishes entertainment, from any one of the four receivers, to the listeners on his little "network." He charges nothing.

The village general store, located not far from the Van Vliet farm, also has a radio receiver from which a line runs into the Van Vliet home and can be patch-corded into the "remote" lines to his barns or to the neighbors. And a two-way line permits him to feed a program to the general store, if they so desire.

Out in the cow-barn, on a shelf, is another radio receiver, used when Mr. Van Vliet wants music while he milks the cows and yet doesn't want the bother of going to the house to turn on one of the other receivers.

Outlet wires from the four receivers are located all over the farm.

He may have a program from Chicago in the hen house, a symphony concert from New York going full blast in the cow barn and a Hollywood network show at the woodpile.

The Van Vliet farm buildings are laid out in a great square, with the woodpile in the center of the square. Overhead dozens of lines cross each other as his intricate system of remote control lines makes it possible to place a speaker at any given spot.

When the day's work is done he sits at his four receivers in the house and

**ON THEIR WAY!**

**BRINGING YOU  
SERVICING DATA  
YOU NEED  
RIGHT NOW**

**RIDER MANUAL VOL. X  
OUT AUGUST 19th**

**1650  
PAGES  
\$10.00**

**T**HOUSANDS of copies of Rider Manual Volume X are on their way to the servicemen of America. The publication date this year has been advanced to August 19th in order to make available to you the tremendous amount of servicing material awaiting publication.

The great number of receiver models being produced by the manufacturers—the new television receivers—facsimile receivers—wireless record players—all have combined to create such a need—such a demand for servicing data that Volume X will be made available 4 months ahead of the usual date.

**NEW SERVICE DATA**

Complete servicing data you need on the receivers now in your shop . . . The data you would ordinarily get in November, ready for you four months ahead of time. The information you have asked us for—in the form you asked for it—all in Rider's Volume X.

**LATEST DEVELOPMENTS**

Television—Facsimile—Wireless Record Players—the servicing information on these important

new developments for the servicemen will be found complete in Volume X. You must have the manufacturer's instructions when you install or service any of these new sets.

**NEW "HOW IT WORKS"**

Easy-to-understand explanations on the theory of Television—Facsimile—Wireless Record Players, etc. are in the new, 64-page "HOW IT WORKS" section which is included at no extra cost. This is the type information you have always found so helpful.

Volume X index covers all 10 Rider Manuals.

*Place Your Order Now*



**YOU  
NEED  
ALL  
10**

**JOHN F. RIDER, Publisher, 404 FOURTH AVE., NEW YORK CITY**



plays first one, then the other, selecting the best programs for their reception.

Under a table, hidden behind a screen, he has two master speakers into which he feeds his favorite program. This, he claims, gives him much more bass and better tone quality.

Van Vliet's living room might easily be mistaken for either a radio repair shop or a ham "shack," so much room do the receivers and their transmission and remote lines take up. He can thumb the radio dial from one end to the other and name every station that pops up along the band, knowing them all.

"The Messiah" is his favorite music. Once he sat up until midnight to hear it. "I wouldn't sit up that late to hear anything else, though," he said.

He won't be content until he finds a radio station broadcasting "serious music," as he calls it, between 5 a. m. and 7 a. m. He continues to twirl the dials of the various receivers each morning during those hours, hoping he'll find one. But he says, "All I ever get is some silly, spooning couples requesting love songs."

-30-



Old Man Centralab is willing to be neutral as to your choice of Volume Control as long as you select one of his famous products... with the wall type resistor strip that hugs the inner circumference of the bakelite housing. Choose one of the Centralab family—STANDARD—MIDGET—or ADASHAFT.



#### STANDARD RADIOHM

The old, reliable "standard" that is 1 3/4" in diameter... used wherever sufficient space for this control is available.



#### ADASHAFT

**KIT** Housed in metal box, hinged, contains ten Midget Radiohms, five types of attachable shafts, etc., for more than 400 makes of receivers.

**Centralab**  
Div. of Globe Union Inc., Milwaukee, Wis.

## TELEVISION BATTLE ON

**T**HE battle for television supremacy is getting hotter from day to day. New York, where it is expected the opening gun of commercial visual broadcasting will be fired, is teeming with rumors and reports, most of the participating companies refusing to state fully their television objectives.

The New York television war concerns itself with broadcasting and not with manufacturing—at least, not yet. But there have been rumors that the Columbia Broadcasting System will seek some revenue through receiver sales. Although this was officially denied, some credence is still attached to the thought inasmuch as its chief competitor—the National Broadcasting Company—is affiliated with the Radio Corporation of America which will definitely be in the video receiver business. Hence, NBC will be able to charge off its huge television transmitting expense (until that day when commercial sponsors pay the bills) to the sales of RCA-manufactured and RCA-licensed sight-and-sound receivers.

A thought here might be, "Won't CBS be dependent on RCA for licensing, if it designs or manufactures its own television receivers?" Even the experts have to guess at the answer. But this much is known: CBS has been using British receivers in its test New York transmissions, with just one RCA exception.

Broadcasting executives have changed their opinions drastically as to the day when commercial television will arrive. The "years and years away" expression has been dropped. Even RCA executives, the most conservative of them all when it came to making television predictions, now concede that television in the New York area will be public-participating by the time of the New York World's Fair in 1939.

But with CBS soon in the field with its transmitter atop the Chrysler Building, it is anticipated that NBC will rush its plan for a regular service to beat its chief competitor.

Columbia's video activities stand to bring a profit to RCA through the ordering of a transmitter made by the latter. This will bring to CBS an almost identical sight-and-sound station as RCA has installed for its own subsidiary—NBC—atop the Empire State Building. There is one big difference in the set-ups, however. While NBC will be limited to its own parent company's products, CBS intends to supplement the RCA apparatus with Farnsworth and other equipment. Columbia had anticipated to be on the air with its Chrysler Building station by the time this issue reaches print, but a delay by RCA in completing the transmitter may postpone the opening until late summer or early fall.

With considerable reconstruction of the Empire State transmitter going on at present, it is now believed that both networks will be able to start regularly scheduled program services at approximately the same date. Not only are the chains trying

to keep quiet on television, but they seem to be pleased by the sudden spurt of facsimile publicity inasmuch as it is something that will keep listeners' minds off television during the period of both intentional and inevitable delay.

It is the opinion of most advertising men that facsimile broadcasting doesn't stand much chance of commercial success but is obviously an "in-between" device, designed to fill in the period between sound and visual broadcasting. The advertising men hold that the people waited long enough and won't be satisfied with anything but the real thing. Facsimile, they admit, has value in the field of commercial communications, but not in broadcasting. There is the initial cost and operating expense of the device to contend with as against the low cost of a morning newspaper.

It will be a limited market at best for advertisers—and advertisers are men who are interested in coverage and not novelty. But the same men are convinced that television itself will find many leading sponsors at hand ready to underwrite the costs. They believe that even though this, too, will be a luxury market at the start, the publicity that goes with the prestige of pioneering will make it pay.

One disconcerting note has been the slowness of American television progress as compared to the rapid pace set by the new art in England. Conceding the fact that our problems are greater than Great Britain's, particularly the finding of a successful system of "networking" for the syndication of programs throughout the United States, the public has long felt that it should participate in the development of the art.

-30-

## What Is High Fidelity?

(Continued from page 22)

If we combine all three of the forementioned requirements for high fidelity transmission we have a setup with which our ears can find no fault. Reduced to technical terms, we must have: a frequency response uniform within 2 decibels from 30 to 12,000 cycles per second; a maximum distortion factor of 3 percent; and a phase shift of less than three complete wavelengths. Needless to say, few if any present day broadcasting stations fulfill completely all these requirements, most of them falling down on the matter of phase shift. However, these requirements are by no means so rigid as to be prohibitive, so we may eventually have true High Fidelity Transmission.

-30-

## Intermittents

(Continued from page 17)

that replacement is in order whether or not visual inspection reveals wear.

This is the first in a series of three articles on intermittents. Next month, "Tester" Bradley will describe some of his typical problems in the field, giving case histories of "intermittents" on various popular models, and classifying each case under one of three causes: heat, voltage, and mechanical failure. Don't miss its valuable pointers.—Ed.

-30-

**QRD?**

(Continued from page 32)

organization. We quote a letter to him from secretary Kleinkaus . . . to go on record in relation to yourself and other radio officers . . . we have never felt apart from other groups of radio officers, our outlook and program is for the obtaining of the same benefits, even though our thoughts as to how these are to be achieved may differ at times, unquote. This news kinda lets us shuteye a bit 'cause we won't have to worry about three unions now. So ends another chapter in the building up of the unity of all radio officers. May they live long and prosper.

**W**ITH shipping and airways looking for new methods and means to expand, new jobs are being opened daily to those who can qualify technically. And who forgot that television was just around the corner two years ago? Well, it's not too late now! So with this for a nightcap and 73 . . . ge . . . GY.

-30-

**RADIO STATION GETS ITS MAN**

**■** THIS is your station, CFGP, the Voice of the Great Peace River Country. We have been asked by the Royal Canadian Mounted Police to make the following announcement: On Saturday night or early Sunday morning, the store and postoffice of C. Larsen at Buffalo Lakes was entered, and the safe and contents removed. Listeners are requested to report the presence of any suspicious strangers or any circumstances they think might in any way connect with the robbery, to the R.C.M.P. at Grande Prairie. I will repeat . . ."

It was the new station on 1200 kc. with a power of 100 watts, located at Grande Prairie, Alberta (1700 Pop.), transmitting from a slight elevation which can be seen for miles around.

Listeners tuned in that Monday morning sat up in surprise. Robberies were almost unknown in the Peace River country of northern Alberta. Geographically isolated from the older settled plains and 400 miles north of the city of Edmonton, this area did not attract criminals. Vast as the territory is, being larger than South Dakota, Kansas or Idaho, it is an agricultural land with only small towns, hamlets and farms where no stranger could long remain hidden, since every one knew his neighbor. And there is only one way out, along the highway or railway to Edmonton. Only an experienced hunter or trapper would dare take to the mountains; and robbery is not in their line. So the criminal must still be in their midst.

The voice of the announcer filled a little log homestead west of Woking in the thick bush country, thirty miles from

*Hot off the Press . . .*

**THIS 56-PAGE CATALOG OF THE HOTTEST SOUND LINE IN HISTORY!**



Here are the contents of this catalog

ACCESSORIES • AMPLIFIERS: Amplifier Units, Amplifier Cabinets (Metal), Cables for Amplifier Remote Controls, Input Transformer, Mixer and Mixer Pads, Panels for Amplifier Cabinet, Remote Control Devices, Signal Mixer Units • ANTENAPLEX (Multi-Wave) • ANTENAPLEX (Standard) • Baffles (see Loudspeakers) • COMPLETE SOUND SYSTEMS • CHIMES (Electric) • CONTROL CABINETS • HEARING AIDS • INTER-OFFICE COMMUNICATING SYSTEMS (Victor-Phones) • LOUDSPEAKERS: Baffles, Control Devices, Electro-Dynamic Speakers, Field Supply Units, Housings and Boxes, Matching Transformers, Permanent Field Speakers • MASTER CONTROL SYSTEMS (De Luxe) • MASTER CONTROL SYSTEMS (Junior), Typical Master Control Installations • MICROPHONES AND ACCESSORIES • MOBILE PUBLIC ADDRESS SYSTEM • PORTABLE PUBLIC ADDRESS SYSTEMS • PUBLIC ADDRESS SYSTEMS: Series Systems • RECORDING EQUIPMENT: Accessories, Recording Blanks • SOUND POWER TELEPHONES • TURNABLES: Accessories and Records • VICTOR-PHONES • VOLUME CONTROLS • WIRE AND CABLE.

**SEND FOR YOUR FREE COPY TODAY!**



Get your free copy today from your RCA distributor, or mail this coupon.

Plan now to cash in on a huge market with

**COMMERCIAL SOUND**

RCA Mfg. Co., Inc., Camden, N. J. A Service of Radio Corp. of America

Commercial Sound Section, Dept. 0-0  
RCA Manufacturing Co., Inc.,  
Camden, N. J.

Please send me my copy of the new  
RCA Sound Equipment Catalog.

Name \_\_\_\_\_

Address \_\_\_\_\_

City \_\_\_\_\_

State \_\_\_\_\_

Any sound system sounds better equipped with RCA Radio Tubes

**WHAT'S UP THERE?**

By

**D. W. TOMLINSON**

Here's an intensely interesting story of aviation in the stratosphere. An informative article by a veteran airman, an ace in the United States Navy, and an engineer with TWA. Aviation is going up into the stratosphere, and the potent question "What's Up There?" is of prime importance to every modern person.

Read this and other significant flying articles in the

**AUGUST ISSUE**

**POPULAR AVIATION**

America's Top Aviation Magazine

**NOW ON SALE AT ALL NEWSSTANDS**



Grande Prairie. A queer, tingling sensation, like a tiny electric shock, ran down the spine of the man beside the small battery radio. The news clicked!

The morning before a stranger who seemed in an uneasy sort of hurry had come to him and asked to borrow a cold chisel and a sledge hammer. He explained that his car had broken down about half a mile away. The homesteader had wondered at the time why the heavy tools were needed. But in that lonely part of the country, where roads into the bush are only trails, help is given unquestioningly. Later in the day the tools were returned and he forgot the matter.

But the announcement set him thinking. He walked down to the road and there in the light snow he found the track of a car that had turned off into the bush. He followed it and came upon the remains of a fire in which many papers had evidently been burned. In a little hollow, partly hidden by snow and branches, he discovered the battered remnants of a safe. No wonder such heavy tools had been required!

The man hurried home, saddled a horse and rode to the nearest 'phone, five miles away. Soon the entire force of "mounties" south of the Peace River were concentrated in that heavily-wooded area. By eight that night they

found a little log cabin deep in the woods and in it, two young men, fast asleep. The money was all there, but the postoffice papers and other documents had been burned. Taken to Grande Prairie, they were tried and sentenced the same night and the following day transported by train to the jail at Fort Saskatchewan.

At the time of the robbery they had cut the telephone lines to the store but they had forgotten about the power of radio. CFGP had justified its existence of one short week.

-30-

### Freq.-Monitor Receiver

(Continued from page 30)

supply is filtered with an r.f. choke consisting of twenty turns of number 16 enameled wire wound on a 1/2" air core. All electrical values are given in the diagram. Referring to the bottom view of the receiver, two intermediate supporting shields may be seen. It is necessary that the entire bottom have a shield plate, thus isolating the monitor from the rest of the receiver.

#### The Receiver

The receiver proper consists of nine tubes. An r.f. stage is provided on all four bands with separate coils used for each stage. Ceramic insulation is used for coil forms on high frequency bands of the r.f. stage. The 6SK7 r.f. tube is mounted vertical to and on the front supporting panel. Grid leads are kept to a minimum in length in this manner. It will be noted that the new single ended type of tubes are used throughout with the exception of the mixer. This provides considerably higher efficiency than can be obtained with the grid cap type.

The tube layout may be easily seen in the top picture. The 6K6GT monitor oscillator tube is under its own shield. The 6V6 output tube is next. Just back of the monitor drum is the 6H6G noise limiter. The 6SQ7 and two 6SK7's are beside their respective i.f. coils. The 80 rectifier and 6SF5, vacuum tube voltmeter R meter amplifier are at the near end of the chassis.

The crystal input, crystal output and the second i.f. stage are wound on iron cores. The output i.f. is air core for maximum voltage to the diode of the 6SQ7. Over 4 watts of audio may be had from the 6V6 output tube. The 6H6 is a noise limiter of the most advanced type for high frequency work. Cut off is at 85% of the modulation peak and may be depended upon to reduce to a minimum interference of the high frequency auto ignition type. No variable adjustment is needed for the limiter. A switch is provided for cutting it in or out of the circuit.

Electrical band spread is provided over a 240° scale. Tuning reduction is about 6 to 1. Chassis dimensions are quite small for a ten tube set. Overall length is 17 inches and depth

is 7 3/8 inches. The chassis depth is 2 1/4 inches. The dial front panel is 15 inches long and 3 inches high.

Terminals on the back of the chassis provide for single or doublet input. Terminal strip for the speaker output is for a 5 ohm voice coil. A muting type of phone jack is also provided.

-30-

### Hamchatter

(Continued from page 28)

pole and the framework, he even has the hole dug in which to put the pole. It will rotate on one half of the front axle and wheel of an old *hearse!* Of all things!!! The whole thing will cost him about \$30.00. He runs 110 watts on 20 meters.

If any of you want a QSO with a real Mountie, just call VE4ACR on 75 or 20 meters. Usually 75 meters. He goes by the name of Constable Bob Brown and uses about 400 watts. Location is Regina, Sask.

VE4KG running 20 watts to an 807 got an R9++ report from a K6 on 20 meters. He doesn't use a rotary beam either! He nearly burst with pride.

Ernie Strong, VE4QD, is engineer at station CKCK in Regina.

VE4BD in Regina used to use an *8JK* rotary for his transmissions, until a high wind blew it down. He is now building a rotary using home-made elements of copper tubing. 4BD and 4UK bought the front axle and wheels of an old *hearse*. What? Again? They cut it in half and now it's a race to see who gets his beam up first. (Secret—it cost them \$2.00.)

VE4UK thinks NX2L is a bootie. He heard NX2L come in here with an R9 signal.

The hams of Regina, Moose Jaw and territory are going to have an outing at Regina Beach on July 1, which, in Canada, is Dominion Day. This will take the place of a hamfest. No fancy prizes will be given. These hams are tired of the racket of bothering manufacturers for prizes.

-30-

### Serviceman's Cases

(Continued from page 41)

Noisy reception, 1) intermittently open-circuiting primary winding in one of the i-f transformers. Replace with new unit and realign the receiver circuits

Sustained . . . 1) carbon resistors have altered in value. Most likely offenders are: the 0.1-meg. '24A second detector screen grid resistor; the 20,000-ohm '24A second det. cathode resistor; and the 40,000-ohm oscillator grid leak. Replace all three resistors

#### ATWATER KENT 84

Inoperative . . . 1) defective oscillator coil. Replace with new oscillator coil, realigning oscillator at 1500 kc. by means of the trimmer on top of the oscillator tuning condenser. Then adjust the oscillator for 800 kc by means of disc at bottom of coil  
2) oscill. plate-tuning cond. (at right of chassis, looking from front) "shorted"

Weak reception 1) excess wax from field coil melting and working into the air-gap and voice coil section. freezing the latter

Poor volume, or 1) open-circuited in i-f de-coupling choke, due to broken leads at lugs under the protective wax

Oscillation. . . 1) replace resistor from grid of '27 oscillator tube to

# FREE!

*and it saves you*  
**TIME,  
TROUBLE,  
MONEY**



This FREE catalog is your dish. Has everything in Radio — thousands of parts, tubes, Test Instruments, Sound Systems, Receivers, build-it-yourself kits, etc. Every item nationally advertised, arranged for quick, easy reference. Order at home. Save time and trouble. And take advantage of real money saving prices. Not just on some items. There's value after value right through this book's 188 pages. You save on everything you buy! Send at once for your copy. Remember, it's FREE! Just tear out and mail the coupon NOW.

## LAFAYETTE

RADIO CORPORATION  
WHOLESALE RADIO SERVICE CO., INC.

Rush New FREE Catalog No. 76

NAME \_\_\_\_\_ PLEASE PRINT

ADDRESS \_\_\_\_\_

CITY \_\_\_\_\_ STATE \_\_\_\_\_

**LAFAYETTE RADIO CORPORATION**  
Dept. 2H9 — 100 Sixth Ave., New York, N. Y.

PASTE COUPON ON PENNY POSTCARD

SALES OFFICES IN

NEW YORK 100 Sixth Avenue

CHICAGO 901 W. Jackson Blvd.

ATLANTA 765 Peachtree Street

Boston, Mass. Bronx, N. Y.

Newark, N. J. Jamaica, L. I.

whistle near 700 kc) "ground" with one of 50,000 ohms

Motorboating...1) check second detector bias and screen resistors. Replace if necessary

**ATWATER KENT 84 D.C.**

Low volume...1) open-circuited connection at lug of choke connected between the I-F blocking condenser and the volume control

**ATWATER KENT 85**

See also Case Histories listed for Atwater Kent 80

Intermittent...1) poorly soldered connections. Check by wiggling every connection and connecting terminal, as well as wires through shields, etc., with the set in operation

Noisy reception 2) peeling condenser plates, causing intermittent short-circuits between plates. Burn with high voltage

Intermittent...1) replace resistor from grid of whistle near 700 kc

Poor tone, low volume, poor response with tone control set at "bass" position 1) r-f choke in pentode control-grid circuit "open." Set analyzer may not reveal this trouble

Poor control of volume (sharp volume cut-off) 1) defective type 24 AVC tube (even though it may test O.K.) 2) "grassy", or high-emission AVC tube 3) if there is no plate voltage on 37 detector, replace plate-to-ground by-pass

**ATWATER KENT 86**

Weak and distorted, inoperative 1) output tube grid choke "open"

Poor control of volume 1) "grassy", or high-emission AVC tube

**ATWATER KENT 89**

See also Case Histories listed for Atwater Kent 80

Oscillation...1) change in value of 425-ohm bleeder resistor. Replace with 1-watt unit

Noisy reception 1) noisy type 35 variable-mu tube (even though it may test O.K.). Replace with new tube

Neon tuning indicator inactive...1) remove shield from first i-f coil. Scrape away the black sealing compound between the plate and grid i-f coil all the way down to the cardboard tubing on which the coils are wound. This should cure the trouble

**ATWATER KENT 91**

Inoperative...1) see Case History for this same trouble listed under grid voltage, Atwater Kent 96 receiver (180 volts, on i-f tube)

Neon tuning indicator inoperative

**ATWATER KENT 92, 94**

See also Case History listed for Atwater Kent 80

Set dead, but becomes operative after a few minutes, building up to normal reception in about half an hour...1) short-circuiting trimmer condensers. Clean the trimmers with alcohol and replace the mica strips inside them

(To be continued next month)

-30-

**Asiatic S.W. Log**

(Continued from page 34)

- stations on the air at this time of day.
- 11.705 meg., JLG3, Tokyo, Japan; relays the Overseas Programs of Broadcasting Corporation of Japan from 11:30 a.m. to 1 p.m., and from 1:30 to 2:30 p.m.
- 11.73 meg., JWV3, Tokyo, Japan; relays programs from the Japanese National Network from 10:40 to 11:30 p.m., and from 1:50 to 4:40 a.m. Excellent volume reported by listeners in all parts of the Pacific Coast.
- 11.80 meg., JZJ, Tokyo, Japan; relays programs on Overseas

- Broadcasts from 4 to 4:30 a.m., and from 5 to 6:30 a.m., working simultaneously with JZK (15.16 meg.) and JLU3 (15.135 meg.). In the autumn, JZJ will also be used from 5 to 5:30 p.m. and from 9:30 to 10:30 p.m.
- 11.88 meg., VLR3, Melbourne, Australia; heard with fair volume from 10 p.m. to midnight, usually broadcasting horse races and recorded music. Sometimes heterodyned by TPA3.
- 11.90 meg., XGOY, Chungking, China; new station which has replaced the old 9.50 meg. frequency. Excellent volume from 3 to 7:50 a.m. daily.
- 15.135 meg., JLU3, Tokyo, Japan; new station now in use for relay of JZK (15.16 meg.) during Nipponese Overseas Program between 5 and 6:30 a.m. daily.
- 15.16 meg., JZK, Tokyo, Japan; used for Overseas Programs of Broadcasting Corporation of Japan from 11:30 a.m. to 1 p.m. (weak); from 9:30 to 10:30 p.m. (very good); from 4 to 4:30 a.m. (good); and from 5 to 6:30 a.m. (good).
- 15.19 meg., XGOX, Chungking, China; formerly on the air from 6:30 to 8:30 p.m., but now temporarily shifted to 17.80 meg. Will probably return to this frequency in near future.
- 15.29 meg., VUD4, Delhi, India; heard with fair volume from 6:30 to 7:30 p.m., nightly (extremely close to Germany's DJQ on the dial).
- 17.78 meg., JZL, Tokyo, Japan; used for Overseas Programs of Broadcasting Corporation of Japan from 5 to 5:30 p.m. daily. Excellent volume.
- 17.80 meg., XGOX, Chungking, China; now on the air experimentally from 6:30 to 7:30 p.m. daily, but may be switched to 15.19 meg. at almost any time.
- 18.83 meg., PLB, Bandoeng, Java; now used only for phone, but usually heard with excellent volume near 4 p.m.

**Across the Dial at 6 A.M.**

This is the first of a series of sections designed to show west coast listeners just which overseas stations may be heard at various hours of the day and night. Stations listed include only the strongest and most reliable. This month the hour is 6 a.m.

- 4.27 meg., RV15, Khabarovsk, U. S. S. R.
- 5.14 meg., PMY, Bandoeng, Java.
- 6.00 meg., XYZ, Rangoon, Burma.
- 6.08 meg., CRY9, Macao, Portuguese China (Mon., Wed., only).
- 6.13 meg., "Radio Saigon," Saigon, Indo-China (off at 6:15).
- 6.20 meg., "Radio Boy Laundry," Saigon, Indo-China.
- 6.72 meg., PMH, Bandoeng, Java.
- 6.98 meg., XPSA, Kwei Yang, China.
- 7.28 meg., JLG, Tokyo, Japan (off at 6:00).
- 9.50 meg., KZRG, Manila, Philippines (off at 6:00).
- 9.53 meg., ZBW3, Hongkong, China.
- 9.55 meg., YDB, Sourabaya, Java.
- 9.57 meg., KZRM, Manila, Philippines.
- 9.58 meg., VLR, Melbourne, Australia (Sat. only to 6).
- 9.59 meg., VUD2, Delhi, India.
- 9.59 meg., VK2ME, Sidney, Australia (Sun. only to 6).
- 9.61 meg., ZRK, Johannesburg, South Africa.
- 9.62 meg., JFO, Taihoku, Formosa.
- 9.69 meg., ZHP, Singapore, Straits Settlements.
- 10.26 meg., PMN, Bandoeng, Java.
- 10.53 meg., JIB, Taihoku, Formosa.
- 11.00 meg., PLP, Bandoeng, Java.
- 11.80 meg., JZJ, Tokyo, Japan.
- 11.90 meg., XGOY, Chungking, China.
- 15.16 meg., JZK, Tokyo, Japan.

-30-

**RADIO ENGINEERING**, broadcasting, aviation and police radio, servicing, marine and Morse telegraphy taught thoroughly. 48 weeks' engineering course equivalent to three years' college radio work. School established 1874. All expenses low. Catalog free. DODGE'S INSTITUTE, Oak St., Valparaiso, Ind.



**JOIN OUR RECORD CLUB**

Send for your copy of this big 500 page Record Catalog & Encyclopedia. Contains lists of thousands of famous records and musical data on pronunciations and dates of composers; 25¢ plus 10¢ for mailing (stamps or coin). It also enrolls you in our Record Club. We carry a large selection of records from 10¢ up. Write today

Dept. 58 Cortlandt St. **MODELL'S** 302 New York City



**THE "REA" PORTABLE ANTENNA**

ONLY portable antenna suitable for all broadcast band reception. Triple pickup. Stops interference. Switch in lead-in to increase power in heavy weather. Output meter tests show it to be superior to any other antenna. Best materials. Moisture-proof. Can be used in any position, or placed in radio cabinet. Size 12" x 3". \$3.85 postpaid.

**Louisville Radio Antenna Co.** Box 53, Highland Park Sta., Louisville, Ky.

**3,313 "CASE HISTORIES"**

FOR RADIO SERVICE MEN!



**RADIO TROUBLE-SHOOTER'S HANDBOOK**

Here is the world's biggest collection of "Case Histories" ever assembled. First published in Ghirardi's new "speed-up aid" for radio service men. This section of the book, compiled from actual service records, will definitely show you how to locate instantly the common weaknesses and troubles in 3,313 models of receivers, representing 177 manufacturers. By far the best thing of its kind available anywhere!

**Get this New TIME-SAVER Now!**

This big book is check-full of all kinds of factory-checked "bench data" boiled down for split-second reference—over 15,000 I-F Peak listings, Auto-Radio Data for Installation, Interference Elimination, Wiring, etc.; Trouble-Shooting Charts; Trade Directories; and over 30 other tables and charts. A book you can't do without—order your copy at once!

518 PAGES, 134 ILLUSTRATIONS, Standard Manual Size (8 1/2 x 11). Fabrikoid-bound. **\$3**

Special Combination Offer: this book together with Ghirardi's world-famous Modern Radio Servicing Book—\$6.50.

**RADIO & TECHNICAL PUBL. CO., Dept. RN-89, 45 Astor Place, New York.** MAIL THIS COUPON AT ONCE

- Here is \$3 (87.50 foreign) for my copy of RADIO TROUBLE-SHOOTER'S HANDBOOK. Ship postpaid with 3-day Money-Back Guarantee.
  - Send BOTH servicing books, \$6.50 enclosed (\$7 foreign).
- NAME .....  
 ADDRESS .....  
 CITY ..... STATE .....

Use it 5 days —OUR RISK! **MONEY BACK GUARANTEE**



## Photographing Equipment

(Continued from page 39)

not be any setting for the aperture. In this case, just forget about it. If you have a choice, as you have in some of the other makes, without the aperture being numbered, use the smallest opening that you have. It will be about right.

If you are using *Eastman Panchromatic Film*, the exposure will be 10 seconds with the same opening and light as above. Faster films will use both smaller openings and less time. That is a subject for experimentation, and at this stage of the game should not be attempted by the beginner. Stick to the two types of film described above, and you will have little trouble.

If you have chrome or polished metal parts on your rig, and you want the chrome to stand out as white against the black panel, try holding a white cardboard over to one side and you will notice the reflection of the white card in the chrome. This will highlight the set and also put a lot more life in the rig. Otherwise, the chrome or polished metal pieces would appear black.

Remember that even technical pictures have to have "life." That is the elusive quality that makes for fine radio shots. This is not limited to the professional, but anybody has an even

chance of capturing it. One of the best ways to know whether you are going to get an interesting and exact picture is to squat down beside the camera and put your eye in the place that would be occupied by the film. The picture must look good from there. If you see high-lights, glare,

current is about 25 ma. under full load at 5 meters and values of more than 25 ma. on 10 and 20 meters did not increase the r.f. output into a dummy antenna. The class B zero-signal current is from 10 to 15 ma. and on speech runs up to about 50 to 75 ma. for the average voice.

-30-

## Within Earshot

(Continued from page 4)

a neat panel lettering job, here is how to go about it . . . and get commercial results.

Go to the dime store and buy one of those rubber stamp alphabet sets which are the delight of every youngster. Then go to the paint store and buy some lacquer. Choose a color which contrasts with your panel, like black for grey or aluminum and white or yellow for black racks. Mix your paint thoroughly and spread a little bit on a piece of cardboard. Using the wet cardboard as an ink pad, wet the letter and then imprint on the panel. Eureka! Honestly, that's the way a big outfit does it!

\* \* \*

IT is a known fact that servicemen spend more time and more money on "intermittents" than on any other feature of the radio repair business. Not only that, but *intermittents* lose them more prestige and customers than any other radio ill. We scouted around to find a first class author to write a series on this little known subject. We found a dandy. He is professor of a large radio school, and he teaches the subject. If he does not know it, no one does. He has asked that we withhold his name, and that he be permitted to use a *nom-de-plume*.

We are certain that "Tester" Bradley's articles will not only fill a long felt want, but that they will help many a serviceman over the bump—even though it be an *intermittent* one!

\* \* \*

IN our round of the ham conventions, we have met many of our readers face to face for the first time. They are swell fellows, and we have gotten much from our meetings. We plan to give these gentlemen what they seek in the form of radio material, and we welcome any suggestions from any of those whom by chance we did not have the opportunity to shake by the hand. Remember that with us, your word is what counts, and we can use suggestions on future material and ideas at all times. We aim to please!

\* \* \*

ONE thing we saw in Minneapolis left us breathless in amazement. We saw three different radio stations operating on the same frequency at the same time come through with absolute clarity. No, friends, they were *not* code stations, that is old stuff! These were broadcast signals. Not only that, but the lecturer told his audience that an infinite number of programs could be put over the same

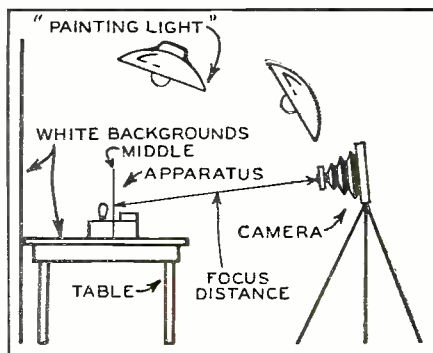

Diagram showing proper lighting.

undesirable shadows, dark or light patches, you may be sure that the camera will record them, only more or less accentuated. What you would see from the position you take behind the camera is what you get on the film. This means that often you must adjust the equipment slightly by changing a rotor of a condenser, or putting a piece of connection wire in a different position or angle so as not to obscure an interesting portion of the picture.

All in all, photography of your favorite unit is a fascinating and instructive procedure. It will pay handsome results if slight care is taken in making the permanent record that you expect from the photograph; it will increase your enjoyment of radio a thousandfold. Try it.

-30-

## 5-10-20 M. Transmitter

(Continued from page 22)

meters were bypassed with .002 mfd. mica condensers since these are near the r.f. unit.

The HK24 tube is no larger than a 45 receiver type tube and yet a pair will provide about 150 watts of carrier without exceeding their plate dissipation rating of 25 watts per tube. The filaments require 3 amperes at 6.3 volts and the amplification constant is 25.

The chassis were all 13" x 17" x 2" and the parts were mounted as shown in the illustrations. There is room for a portable 45 volt battery as C bias for the modulator between the bottom chassis and the rear door. The front panels are, 5 1/4" x 19" for the meters, 8 3/4" x 19" for the r.f. deck and 10 1/2" x 19" for the two remaining units. The cabinet and panels were all finished in pearl grey crackle paint.

Typical plate current readings are as follows: first 6V6G 30 ma.; second 6V6G, 30 to 38 ma.; HK24 buffer 65 ma.; final grid current 40 ma.; final plate current 125 to 150 ma. The grid

# SPRAGUE ATOMS

"Mightiest Midgets of All"

## JUST A FEW ATOMS

Equip You for Hundreds of

### CONDENSER REPLACEMENTS

Tune in on real efficiency! Buy Sprague ATOMS (midget dry electrolytics) in handy kits. A few kits equip you for quick, money-saving replacements on almost any job. ATOMS are smaller than any other midgets. Made in more voltages and capacities including duals with common negative leads. Don't be afraid to use 'em—and use 'em plenty. They've got real "guts." They're unconditionally guaranteed against blow-ups.

An 8 mfd. 450 Volt ATOM lists at only 60¢—a dual 8.8 at \$1.00. Think of the saving! Write for complete Sprague Condenser Catalog—just out.



Sold singly or in handy kits of frequently needed capacities.





wavelength and carrier at the same time. No wheels, nor "choppers" were used, the whole thing was done electrically with simple circuits. We hope to scoop the radio world with a complete article on this unbelievable piece of engineering. We freely predict that should this type of broadcasting come into general use, the whole picture will be changed from the top to the bottom of the spectrum. We might even see amateurs back in their pre-war frequencies of 200 meters and down!

\* \* \*

**OTHER** than this, the lazy summer slowly unfolds, with outdoor sports predominating. It is hard to concentrate on radio at such a time. Perhaps it is better to get a breather now so that you may redouble your efforts when the fall and winter set in. Meanwhile we are going to quit the typewriter for now and go out and play some tennis. So long! KAK.

**Serviceman's Experiences**  
(Continued from page 19)

"does it play?"

"Why—no," she answered, brushing some wet hair behind her ear, "it's been silent since—for more than five years."

"It must be tough, taking care of three children and a big apartment," I remarked compassionately.

"Yes," she sighed, "but one must live!"

I drove back to the shop happily, for I had with me not only the Radiola, but also the old Kolster. I worked late that night, wiring in a new filter block on the free job. To finish it off, I replaced the two 81's, the 87 $\frac{1}{2}$  and the 10. The total came to \$11.27—which made me pause at the cash drawer for a moment, but—enthused by my partner's \$7.16 example—I rang up my money righteously.

The next day I delivered the Kolster, and put up boards across the back of the console and a lock on the swinging doors to protect the shafts and tubes against fore and aft raids by the children.

When the music came up, the woman came from the kitchen. She said nothing, but sat down, laying her head back and closing her eyes. I waited sympathetically until she spoke:

"I wish my husband were here to enjoy it."

It was a tender moment, and my heart welled up within me. "Perhaps," I suggested delicately, "he *does* hear it!"

She looked at me strangely. "Fat chance," she said, "he works more than a mile away!"

"He's still alive?" I asked, "And working?"

"And how!" she said bitterly, lighting a cigarette and snorting out smoke through her nose. "The big monkey took our last ten thousand dollars two years ago and bought into three apartment houses. Now I have to take care

of this one, and he tends the other two. He's too tight to hire extra help. Never again!"

"But the radio," I said, "why hasn't it been running? You couldn't afford a repair. I hope!"

"Oh, *that*," she replied, "I use the midget in the kitchen—it sounds just as good to me, and the kids can't reach it."

When I got back to the shop, Al asked: "Well, what's the report on your free job?"

"The quality of mercy has just been strained," I said, "and, if you don't mind, let's talk about something else. I concede the victory to you—no more charity!"

"That's discouraging," Al said, "especially since my beneficiary was so well pleased with the Columbia repair. It was very worthwhile, and—if it breaks down at any time in the future, I'm going to work on it again—at my own expense!"

Imagine! "Fine!" I said, taking heart anew, "whose set was it?"

"*Mine*," he replied.

"But we agreed—"

"It was perfectly legitimate," Al interrupted. "You'll admit no one would have paid for it if I didn't. Besides, charity begins at home!"

Free jobs are to servicing as ants to a picnic. Don't misunderstand me—I'm not the type of fellow who goes around stuffing gum wrappers into Salvation Army coin-boxes—but after this, if anyone expects gratis work from me, the request will have to be attached to an affidavit of starvation. Charity may have its place, but—during working hours—the best things in life are me.

—30—

**I Tube Auto Converter**  
(Continued from page 18)

detector oscillator unit which converts signals in the 5 and 10 meter amateur bands to some new frequency between 1500 and 1600 kc. This is the "intermediate frequency," which is fed to the car radio tuned to any desired interference-free point in this range and which functions as the conventional i.f.-a.f. portion of a super-heterodyne receiver.

Extensive investigation of tube complements for converter operation has quite definitely indicated the 6K8 to be the ideal answer. It gives maximum conversion gain and freedom from interlocking right down to 5 meters. As the logical choice, it is used as detector oscillator in this instrument.

At the left of diagram is diagrammed a socket to which the antenna and ground connect. By means of d.p.d.t. switch S1, the antenna is either crossed over directly to the similar output socket at the right of Fig. 2, when broadcast reception is desired, or it is passed through the converter. Since optimum coil dimensions for 5 and 10 meter operation are



Dealer Net \$33.00

Model 1696

with New  
**TRI-PLETT**

**MODULATION MONITOR**

- Usable on All Amateur Bands
- Permits Compliance with Federal Regulations

- RED DOT LIFETIME GUARANTEED METERS
- 110 Volt AC 60 Cycle Operation
- Two meters—one for Carrier, one for Per cent Modulation
- Calibrated Neon Light for Instantaneous Peaks
- Tip Jacks for Phone Connection
- Uses Vacuum Tube Rectification

Here is what Hams have been waiting for to help them comply with Federal Regulations... a Modulation Monitor at a moderate price expressly designed for hams by Triplett. Has self-contained carrier level adjustment control and modulation selector can be set for any desired modulation, 50% to 120% on positive peaks; 50% to 100% on negative peaks.

Whenever modulation exceeds the pre-set point—neon light flashes. Meter operates in less than 300 milliseconds for full scale deflection—and has delay circuit on down stroke, thus permitting accurate readings. Pilot light shows on and off condition. Switch can be thrown for observing either positive or negative peaks.

Features and accuracy compare favorably with most expensive types of modulation monitors. The RED DOT on the dial means meters are guaranteed for life against defects in materials and workmanship.

Model 1696 in Metal Case with Black Suede finish. Dealer Net... \$33.00

**Model 666-H**

For all amateur use... 5000 Volts self-contained... Pocket size AC-DC Volt-Ohm-Milliammeter... No external multipliers necessary. Net Price... \$14.50



FREE Technical Data On Request

\$14.50 net price

Enc Triplett Electrical Instrument Co. 158 Harmon Ave., Bluffton, Ohio

Please send me technical data on Triplett New Modulation Monitor Model 1696.  Model 666-H.

Name.....

Address.....

City..... State.....



almost identical, a distinct gain is realized by winding both antenna and oscillator coils as single coils, all of which are used for 10 meters, and the larger half of which are cut out by wave-change switches S2 for 5 meter operation. In the case of L1, all turns below the tap in use are antenna primary—high impedance for 10 meters and low impedance for 5 meters. In

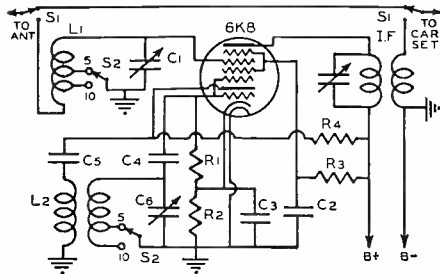

R<sub>1</sub>—50,000, 1 w. IRC.  
R<sub>2</sub>—170 ohms, 1 w. IRC.  
R<sub>3</sub>—25,000, 1 w. IRC.  
R<sub>4</sub>—30,000, 1 w. IRC.  
C<sub>1</sub>—C<sub>5</sub>—50 mmfd. var. Bud.  
C<sub>6</sub>—C<sub>9</sub>—1 400 v. paper Aerovox.  
C<sub>2</sub>—50 mmfd. mica Aerovox.  
C<sub>3</sub>—500 mmfd. mica Aerovox.  
I.F.—Spec. output trans.  
L<sub>1</sub>—Guthman 4393.  
L<sub>2</sub>—Guthman 4394.

Circuit diagram of the converter.

effect, a portion of the 10 meter secondary becomes 5 meter primary in addition to the regular 10 meter primary when bands are switched. This

eliminates any possibility of dead-spots due to resonating primaries in either band, and at the same time makes for maximum simplicity of circuit switching, and maximum possible secondary inductance which is so necessary to real performance at 5 and 10 meters. The tuning capacity necessary to cover each of the two bands is only 19.7 mmfd.!

The oscillator coil is treated in the same manner, except that its unused

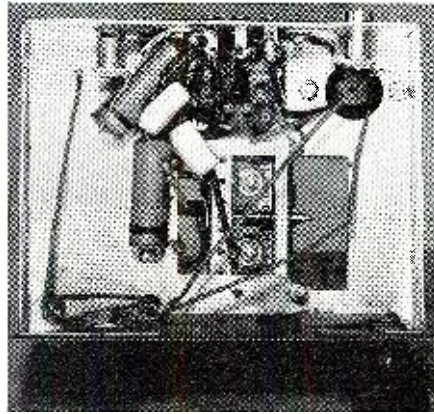

Under chassis view of converter.

secondary coil is short-circuited to prevent absorption losses since it does not readily lend itself to shift into a plate tickler. The actual tickler is a separate winding so proportioned and coupled that it results in strong, stable oscillation on both 5 and 10 meter bands. The tuning condenser uses X2B insulation, electrically equal to ceramic, and mechanically acceptable for mobile equipment. The balance of the parts are clearly visible, including the special output coupling transformer which must be tuned by its trimmer screw to the desired output frequency for the regular auto set—something between 1500 and 1600 kc. as previously mentioned.

—30—

### 112 MC Transceiver

(Continued from page 31)

#### Construction Notes

For the front panel and sub-base support, bakelite or masonite material can be used. Drill these panels for the parts to be mounted and include the holes for fastening the L-bracket supports. The base can be a piece of plywood about 5" x 10".

While wiring the components remove the tubes. The wires should be as short as possible. You will find that in the placing of the coil and tuning condenser directly in back of the tube socket, the plate and grid leads will be practically non-existent.

The RF coils may be made by placing 80 turns on  $\frac{3}{8}$ " diameter rod, wound at random. No. 30 enameled wire will serve. Regular 5 meter R.F. chokes may be used instead.

The tank coil is made from No. 14 bus bar, wound on  $\frac{1}{2}$ " form, and has four turns. This coil should be used with 15 mmfd. condenser and will just reach the lower end of the 2½ meter band switch condenser closed.

Much pioneering on this band is being carried on the South side of Chicago. Fred Klittich, W9HND, has equipment of this type, both at home and in his car, and has tried for antenna purposes everything from a bed-spring to a 160-meter antenna. The best results were obtained when an antenna was fed through a small 3-30 mmfd. coupling condenser, connected one-quarter turn away at the plate end of the inductance used. The actual antenna employed made very little difference although the 8-foot rod will give about the best results. One of the tests was conducted with the assistance of W9ELH operating his 2½-meter transceiver in the basement of a large building. While W9HND was driving in the vicinity using a portable transceiver of this type. It appeared that when the obstructions are present very close to the transmitter, the waves have actual penetrating power and also are able to turn slightly from their path. The basement transceiver was located on the corner of 58th Street, and communications up to two miles distant, when a right turn was made, the communications continued for two blocks and then faded out. At a closer distance, when turning a corner blocked by a large apartment building, the signal instantly faded out; but from all indications the carrier was not blocked as sharply as the sight of vision, and visual distance was not the actual limiting factor.

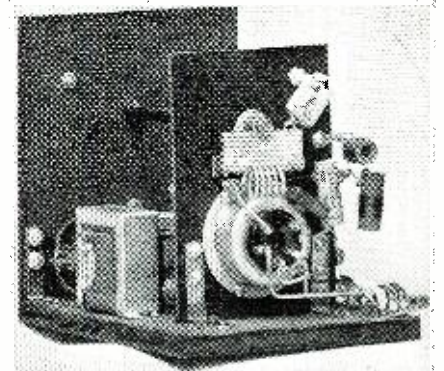

Rear view of transceiver.

On another occasion these two hams worked a three-way contact, having W9WGD to join them in the operation. The three stations were located at imaginary vertices of a triangle and had no difficulty in carrying on a conversation between themselves. It was also possible for any one of the stations to pick up either of the other two while both were transmitting at the same time.

However, when the stations were in a straight line, the oscillation produced by the middle receiver prevented direct contact between the two outlying stations.

In using this equipment, it will be found that in shifting from "transmit" to the "receive" position, the frequency adjustment will be altered because the actual inter-electrode capacities of the tubes are different when

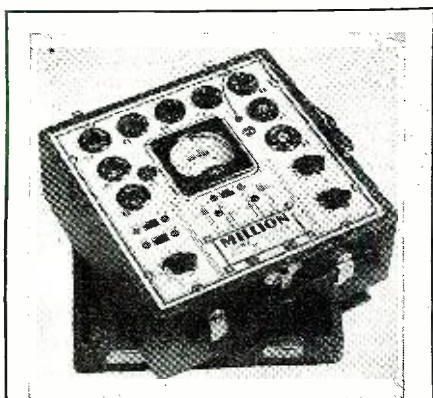

## • MILLION • NEW DF TUBE CHECKER FOR ALL NEW TUBES

New, with wider application range. Tests emission of all tubes. Ten sockets cover all types from "hearing aid" peanut tubes to the new 10K10s and S series. Filament switch covers 1.4 to 110 volts with spare positions for the future. Gives instant "good-bad" readings on oversize D'Arsonval meter. Makes neon short or leak test with tube hot. Tests by-pass condensers, etc. Literature on request.

MODERN  
ACCURATE  
DEPENDABLE  
ECONOMICAL

\$16.95  
NET

If your Jobber cannot supply you,  
write us direct.

MILLION RADIO AND TELEVISION  
577 No. Union St., Chicago, Illinois



used as an oscillator or as a detector. A slight change of the tuning condenser adjustment will be needed to bring the carrier in once again.

The equipment needed for 2½-meter operation is simple and inexpensive. Actually good results can be secured over short distances up to about five miles in open country, and real opportunities for pioneering are available on this band. -30-

**What's That Noise?**

*(Continued from page 23)*

business districts, this sort of QRN is annoying. Adding machines, cash registers, hair dryers, and other commercial equipment churn up clicks and whirrs entirely out of proportion to the size of the machine. Worse, some of the equipment is far from small. Trolley cars, el and subway trains are notorious instances. While they are starting, it would seem that their commutator segments can be counted.

Often the pattern identifies the source. In the case of cash registers and adding machines, the click is followed by a short whirr which stops on another click. If the device is an electric sweeper or mixer the whirr continues, and at virtually the same pitch as the sound of the machine.

The time at which the noise occurs also may tip off its source. A pre-breakfast whirr often betrays an electric razor, or a whirr at bedtime a massage vibrator.

The most annoying and widespread electrical interference is neither click nor whirr, but an a.c. note. This has the same pitch as a transformer under load. However, its quality is more a ragged buzz than a smooth tone. Also, it may be steady or sporadic, according to its cause.

Steady a.c. buzzes are due, almost invariably, to poor contacts or actual arcs. A few years ago it was standard practice to blame the utility for all such noises. But embarrassing experience has shown that most of them are much nearer home.

For instance, when a lamp is on its last mile the filament often breaks, forming an arc across the ends. The bulb may be an insignificant 50-watter. But the roar that booms from the loud-speaker will suggest a 66,000-volt line spitting over to ground.

A loose plug in a wall receptacle or on an appliance such as an iron will produce much the same din. Even when properly connected, the violet-ray machine does a superb job of ruining reception, since it uses a constant a.c. spark.

Among commercial devices, the neon sign is a fecund producer of steady a.c. buzz, unless it is properly installed and maintained. The volume may not be high, but it goes on far, far into the night.

Any loose connection in home wiring will cause an a.c. buzz, while power is flowing in the circuit. Whenever a steady buzz develops it is a good plan

to tighten every attachment plug and lamp, then turn off all branch circuits except the one feeding the receiver, in order to smoke out the cause.

Now and then, of course, such interference is due to high lines. But more often their QRN is sporadic. Intermittent high-line buzz generally occurs during gusty winds which blow trees against wires, or rain or snow which cause arcs across insulators.

A wide variety of equipment may also cause sporadic a.c. buzz, even when it is in good operating condition. The X-ray is an example. Near the office of a doctor or dentist or a hospital, much radio noise can be traced



Quality above all

**ALL TYPES OF  
FIXED CAPACITORS  
FOR RADIO AND  
TELEVISION . . .**

Catalog on Request

**SOLAR MFG. CORP. Bayonne, N. J.**

**HELP! YOU HAVE SWAMPED US**

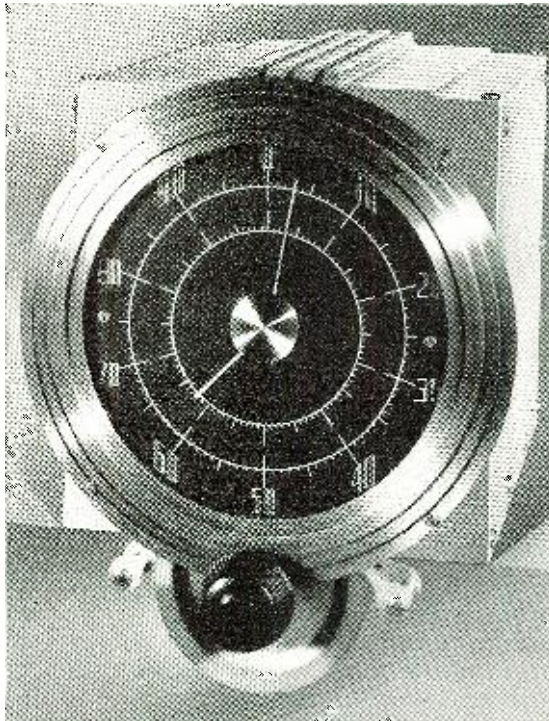

MODEL RX-18—ALL WAVE TUNING ASSEMBLY. NO GANG-SWITCH—NO PADDING CONDENSERS. PLUG-IN COIL EFFICIENCY. PATENT PENDING.

Not so long ago, we announced an ALL-WAVE TUNING ASSEMBLY completely eliminating the gang-switch.

We had expected this to make a stir, but we were not prepared for the volume of orders and inquiries that poured into our hands.

At present, we are engaged with the designing and engineering of several types of gang-switchless tuners and other new inventions which will be manufactured by our organization.

As soon as our new and enlarged production facilities are completed, we will, through the medium of the popular radio publications, announce for sale and have available for immediate delivery a complete line of our new products.

We thank you for the tremendous response and interest you have shown us, which was little less than spectacular.

Cordially yours,

Pierre P. Pattyn, Pres.

**U. S. RADIO PRODUCTS, INC.**

16710 NINE MILE ROAD

EAST DETROIT, MICHIGAN

*Now..* **STANCOR** *Gives You*



**"Thorobreds"**

**The World's FINEST Transformers**

*New Eye Appeal*—beauty such as you've never seen before  
*New Efficiency*—performance that surpasses anything hitherto known . . .  
*New Construction*—sturdy, rigid, lasting durability . . .  
*New Safety*—an achievement never before so perfectly accomplished!

Ultra modern design . . . visible terminals—fully protected . . . extra heavy porcelain insulators . . . and other advanced improvements.

See these new Stancor "Thorobreds" now at your Jobbers or write us for Catalog No. 140A.

**STANDARD TRANSFORMER CORPORATION**

1500 N. HALSTED ST.

CHICAGO



to X-rays. For dental photography the buzz lasts only a few seconds. But when treatments are being given it may go on for as much as an hour.

Another semi-medical device, the electric warming pad, is a potential source of sporadic buzz. The better makes are interference-proofed. But inferior types kick up an incredible din for their modest wattage.

Until manufacturers saw the light, oil burners were among the worst offenders in the intermittent buzz department. Now their ignition systems are filtered. However, thermostats and other controls sometimes fail to open circuits promptly, causing arcs that may last two or three minutes.

The most notorious source of hit-skip QRN is the diathermy machine. Using considerable radio-frequency power, it generally turns up on one of the short-wave channels, hovers there a few moments, then flits to another spot. For this reason it seems sporadic. Actually, it produces a constant a.c. buzz, only the carrier frequency shifting.

Other equipment produces a somewhat similar effect. An a.c. buzz, either steady or sporadic, often appears in only one part of a receiver's tuning range, or will show definite peaks along the dial. Sometimes this is due to variations in receiver sensitivity, again to the type of radiation. It is not uncommon to find a.c. noises with harmonic peaks, starting in the

broadcast band and extending through the short waves.

What can or should be done when the characteristics of a given noise have been noted?

Today interference hunting is a specialty. Few swls or even hams are prepared to track down bad cases of QRN arising outside their homes. But nine cases out of ten, the source is on the listener's premises. In a majority of these the trouble can be corrected easily by applying a suitable filter or repairing defective equipment.

If no source of noise can be found in the home the indicated move is to ask the cooperation of the utility. And, please note, cooperation is a two-way street.

The professional interference hunter is in much the same position as a detective. If he is to get the culprit, he must have clues to follow. In his own interest, it is up to the listener to supply all the clues he can.

So a report of interference should take the form of a log, preferably covering several days, and showing the exact time when the noise occurs, along with its audio characteristics. Armed with such a report, the professional interference hunter can set about his job intelligently.

It must be remembered, too, that the utility cannot squelch noises beyond its control. It may not be able to persuade Aunt Minnie to discard her violet-ray or Uncle Elmer to stop shaving while the Aussies are coming in. Even so, there's a sour satisfaction in knowing who deserves the cussing when man-made QRN rears its ugly head above a signal.

-30-

**Sight and Sound News**  
(Continued from page 37)

demonstrations. The meeting lasted three hours.

**TELEVISION ADOPTS WINCHARGER TOWER**

HATBORO, Pa.: The Hahn-McPherson Industrial Design Laboratories here are using a Wincharger antenna tower for television. A Johnson 5 meter television type antenna is installed on the extreme tip with a special ratchet and pawl attachment to give a 360-degree rotation. The tower is marked by a red marker light due to the proximity of the laboratory to Pitcairn Aviation Field.

**FREE OPERATING TELEVISION COURSES GIVEN BY BAIRD**

SYDENHAM, England: Baird Television, Ltd., has opened free fortnightly courses in large screen television at its factory here to supply the demand for experienced operators. Four lecturers are in attendance and a diploma is awarded for proficiency. A section of the factory has been set aside for the

classes in theory, practice and general operation of theater entertainment in the Television field. Baird Television recently installed large screen television in the Gaumont British theaters.

**RCA RELEASES COMMERCIAL FACTS ABOUT TELEVISION RECEIVERS**

CAMDEN, N. J.: In a recent bulletin RCA has listed commercial facts about their television receivers. The sets described are the Models TT-5, TRK-12, TRK-9, and TRK-5.

**ELECTRICAL ASSOCIATION SPONSORS PHILLY'S PREMIER TELEVISION DEMONSTRATION**

PHILADELPHIA, Pa.: Under the sponsorship of The Electrical Association of Philadelphia, the first large scale public demonstration and exhibition of television was recently completed at the Franklin Institute in this city. Co-operating with the association were RCA and Bell Telephone of Pennsylvania and the Philadelphia Electric Company.

Visitors were permitted to handle and try out the equipment and material. Over a million paid tickets were distributed for attendance.

**HIGHEST TELEVISION RADIATOR COMES TO HOLLYWOOD**

LOS ANGELES, California: Harry R. Lubcke, world-famous Director of Television for the Don Lee network and Station W6XAO, announced that this city will soon have the highest television radiator in the nation.

"Plans for the new site of Station W6XAO call for antennae at least one hundred feet above the transmitter building overlooking Hollywood. Since the mountain recently purchased by Thomas S. Lee is 1700 feet high, the streamlined antennae will surpass the altitude of New York's Empire State building one and one-half times. Other eastern stations, hampered by the lack of suitable mountain sites, have established their radiators many miles from population centers. The Don Lee station site is only two and one-half miles from Hollywood Boulevard & Vine Street," said the distinguished scientist.

**NEW TELEVISION PICK-UP TUBE ANNOUNCED**

CAMDEN, N. J.: Owners of television receiving sets in the New York area may before long have the pleasure of viewing pictures of clearer detail than have heretofore been possible anywhere in the world. This will happen when a new television pick-up tube, described last night before the Institute of Radio Engineers by Harley A. Iams and Albert Rose of the RCA Laboratories at Harrison, N. J., is ready for public service. The new device is regarded by scientists as one of the greatest single improvements in television since the invention of the Icono-

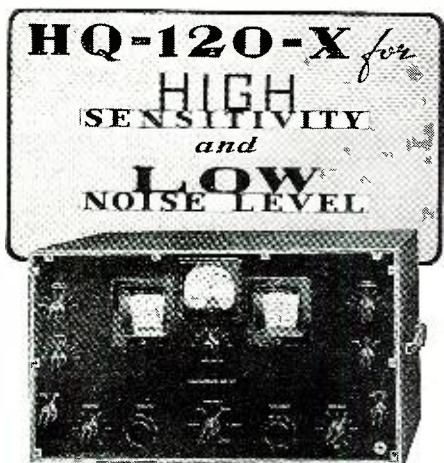

**HIGH SENSITIVITY** and low noise level have made the "HQ-120-X" radio's outstanding low priced receiver. The variable selectivity feature, permits the operator to tune out strong stations and pull in the weak distant stations that would normally be buried in QRM. Remember, the weak stations are there, but it requires a sensitive and selective receiver to get them. If you want the best in high frequency performance, use an "HQ-120-X." Send for booklet!

HAMMARLUND MFG. CO., Inc. RN-9  
424 W. 33 St., N. Y. City  
Send 16-page Booklet.

Name .....  
Address .....  
City ..... State .....

Canadian Office: 41 West Ave. No., Hamilton, Ont.

scope or "television eye." It is applicable to transmission, and therefore necessitates no change in existing receivers to accomplish the improvement.

### NATION-WIDE TELEVISION SERVICE PREDICTED WITHIN FIVE YEARS

SCHENECTADY, N. Y. (Special to RADIO NEWS): According to Dr. W. R. G. Baker, head of the television department of the General Electric Company, within the next five years, hundreds of television transmitters will probably be built and installed—millions of receivers may be in use in homes by 1944. He declared that television ultimately would become an "electronic Peddler" bringing daily to housewives an animated presentation of a store's wares in a fashion made possible by no other medium. Instead of going to the motor shows to see the new models paraded and demonstrated, we will sit in our living room and see this done in a more convincing and dramatic fashion. Our wives and daughters will see the season's new hats and gowns paraded on live models. Television broadcasts over telephone wires, a feat considered utterly impossible, may soon become a reality if experiments now being conducted secretly are successful. Already visual telecasts such as the photo-account of the "Six Day Bicycle Races" in New York, have been successfully transmitted for short distances over specially set-up telephone wires, thus opening the way for possible nation wide network telecasts in the future.

Many dx'ers are of the opinion that a new field for dx may be opened with the widespread adoption of television and believe the day may not be too far distant when dx viewers will treasure QSL cards confirming distant "squints" the same as they do for today's conventional auditory reception.

-30-

#### The Video Reporter

(Continued from page 37)

special event programs—news and sports—are even more important in television than in sound broadcasting. True, the studio offerings will remain the backbone of the program structure. But the special event pick-ups are the things that will draw the heaviest audiences and actually "sell" the public on the idea of owning video receivers.

IN England, "O.B." stands for "Outside Broadcast" and the latter term applies to what Americans call "remote control." At Radio City, "O.B." is an abbreviation also in constant use, and it stands for O. B. Hanson, vice-president and chief engineer. But, in effect, it seems that the application of the initials on each side of the Atlantic amounts to pretty close the same thing. That's because the NBC video lads, under Hanson, are

stepping lively these days providing a wide variety of remote sight-and-sound pick-ups that are real eye-openers.

It's nothing at all for a crew of eleven to hop in the mobile unit of W2XBS and hie to a ball-park or sports arena for a new television "first." The NBC lads have been working fast, apparently trying to get in as many "firsts" as possible before W2XAN—the CBS station—takes to the air. But the scope for new television offerings is so wide that there's no doubt the Columbia men will do plenty of program trail-blazing of their own.

The Video Reporter recently observed a baseball game pick-up and the flexibility of a single camera to cover an entire overtime game was amazing. A few flaws were noted, but that's to be expected in the early stages of the new art. And what is more, slight imperfections are not readily discerned by a public that is astounded at the technical marvels of television. This doesn't mean that production men can afford to be careless. But there are many things that can be best learned by experience alone.

THE use of an ordinary telephone line for conveying television impulses part of the distance between the pick-up point and the transmitter is more important to the industry than any other video feat of 1939. At this point, we must hastily add that we're referring to that part of 1939 from the turn of the year to the time we're writing these lines; this is an essential qualification, considering the rapid strides that can be expected in television.

NBC presented a pick-up by this method and, all in all, the experiment—if you insist on calling it that—was a success. Some viewers were critical of the pictures, others were enthused. But all trade observers concurred that the program was one that may lead to the solution to the ever-present problem of how television can be "net-worked" in the United States.

Bringing television to the small towns and villages beyond the "guaranteed" reception areas mapped out by big-city television broadcasters is essential from the viewpoint of public service as well as the all-important angle of selling video receivers to the rural residents. The high cost of coaxial cables to link nation-wide television chains caused engineers to delve deeply in the subject and the recent actual "on-the-air" test program of a bicycle race relayed from Madison Square Garden to Radio City over ordinary lines (using newly developed amplifiers of the Bell Telephone Laboratories) proved that telephone wires can be used at least a mile. And that's a beginning!

Engineers were modest about the transmission, but even the ultra-conservative experts we approached expressed the belief that, at long last, the \$5,000-a-mile coaxial cable bogey that has hampered plans for practical television networking is beginning to be routed.

THE FCC Television Committee's recommendation that the Commission "neither approve nor disapprove" the video standards proposed by the Radio Manufacturers Association was not a surprise. Even though many trade figures and television enthusiasts were disappointed, the committee action need not be interpreted as a severe setback. There is still considerable clash in the industry itself over the establishment of standards.

The FCC video group requested that the public be informed that the Commission, although failing to approve the standards, does not believe them to be objectionable "as a phase of a rapidly developing service."

"The public," the committee adds, "should also be informed that the Commission desires to be free to prescribe better performance for the transmitters it may license in the future when and if such improvements are proved to be in the interest of the public."

Patents, scarcity of channels, interference and receiver costs were among the factors cited in the report. But the one factor that can do much to retard television progress is mention of a premature acceptance of television.

Actually, the committee didn't say "No" to the RMA standards. But it didn't say "Yes" either. This does not infer indecision; rather, it indicates that caution is being taken to avoid costly industrial blunders. It's not a course all would prefer, particularly with the lead England took in television—and the American industry has been anticipating passing the British video sales total in short time. This may still be done while U.S.A. television remains under the experimental label—a tough merchandising handicap.

After all, "experimental" is just a word. Television can soar onward and upward under that classification even though the going is made a wee bit rougher.

A SUBTLE type of television exploitation was introduced by the Radio Corporation of America at the New York World's Fair. It's a clever idea whereby RCA Communications comes indirectly to the aid of RCA Manufacturing in applying a television plug to the pre-written greeting variety of radiogram which can be sent from the Fair to points in the U.S.A. for twenty-five cents.

## THESE RELAYS

USED IN RADIO NEWS "All-Purpose"

### TRANSMITTER AND RECEIVER

The dependability, responsiveness, low power consumption and long life, characteristic of Ward Leonard Relays, have prompted their use in the Radio News model set. This means that no better Relays are obtainable.

Ward Leonard Remote Control, Antenna Changeover, Push-to-talk, Safety, Time Delay, Overload, Underload and Keying Relays are described in Circular 507B. Send for it.

## WARD LEONARD ELECTRIC COMPANY

47 South Street, Mt. Vernon, N. Y.



HAVING TROUBLE WITH INTERMITTENTS?

Read RADIO NEWS For SEPT. & OCT. 1939



## Get 5 and 10 ON YOUR AUTO RADIO



Easily installed between antenna and your present auto radio, the new GUTHMAN U-39 converter brings you the 5 and 10 meter amateur bands well spread out over its dial, and with all the tuning stability needed to hold signals on these bands after you've tuned them in.

Only 6"x4 5/8" it is the answer for the amateur desiring 5 and 10 meter mobile operation. It's equally good to bring 5 and 10 meter coverage to older communication receivers as well.

This new 5-10 meter converter—and the new U-36, 6 band mobile phone c.w. transmitter-permanent station exciter—were definite hits at the trade show. See them at any up-to-the-minute jobber's—or write for GUTHMAN catalog of these and many other "hot" items.



# Remote Control Your Transmitter

Here's another valuable section of the continued article featuring the

## 940 TRANSMITTER

COMING TO YOU IN THE  
SEPTEMBER ISSUE  
RADIO NEWS

RADIO NEWS, Dept. RN 101  
608 S. Dearborn St., Chicago, Illinois

Enclosed find \$1.00. Send me RADIO NEWS for one year (12 issues) and rush me a copy of the 1939 RADIO & TELEVISION DATA BOOK without charge. (If renewal, check here . If you are a serviceman, please check here .)

Name .....

Address .....

City..... State.....

Under the plan, anyone with two bits can send any one of nineteen standard messages to friends or relatives.

Here's Number Seventeen: "Greetings from the World's Fair. Have just seen the first Television demonstration. It is wonderful."

And quite similar is Number Eighteen: "Television has just arrived. Have just witnessed first demonstration at World's Fair."

For a personal touch, you can use Number Nineteen: "Just seen Television at World's Fair. Wish I could use it to see you."

If the radiograms seem to have a commercial television flavor, it's nice to note that RCA Communications permits the word "Love" or the word "Regards" to be added to any of its fixed World's Fair greeting texts.

MUCH interest has been centered around the television patent policies of RCA—the firm holding so many of the essential patents. Here's the firm's statement on television and facsimile as announced in its new book, "Patent Policies of the Radio Corporation of America":

"In view of the advances that have been made in television and facsimile transmission of pictures respectively of moving and still objects, RCA has not only sold and offers to sell apparatus for such purposes to others, but it has also offered licenses for television and facsimile transmitters to competitors who are capable of producing reliable apparatus of this character."

The statement adds that "about 50 receiver manufacturers are already licensed by RCA for television and facsimile broadcast receivers, and eleven tube manufacturers for tubes for use therein."

ALFRED H. MORTON—"Doc" to everyone at NBC—who has been the network's vice-president in charge of managed and operated stations, was recently assigned as vice-president in charge of television. This appointment reveals the major importance attached to the new art by the chain. Television is no longer a novelty or merely a laboratory topic. This is reflected in executive appointments as well as program plans. Until recently, programs were in the hands of the engineering departments. Now the best of entertainment production names are being recruited for the video art.

TELEVISION for theatres may soon be in use in the U.S.A. The idea has been tried in England and, as a matter of fact, was attempted in this country many years ago. But the Baird Television interests of London now see the field ripe for a thriving business in New York, and I. C. Javal, one of their executives, arrived in New York late in April to start it.

The big problem in television for theatre audiences is that of copyright. Can a theatre charge for entertainment sent over the air free? It may be likely that theatres carrying such a service may eventually have their own transmission which, in the case of prizefights, football games, etc., may be profitable ventures.

HIGHLIGHT of recent New York television transmissions is the exceptional high-quality of programs picked up by mobile sight-and-sound unit. True, the outdoor pickups often lack the composition details and contrasts offered by studio pickups. In the latter, though, lights are under the production man's control. He can't control Old Sol, but it seems that the sun has been very accommodating, nevertheless. Outdoor pickups have compared very favorably with newsreel shots—and you must remember that the latter have the advantage of laboratory doctoring before being shown.

-30-

### Bench Notes

(Continued from page 15)

caused by twisted voice coil mountings. The normal quality from these fourteen-inch speakers is pleasing to

most ears—but not after wet air gets to work on the thin paper stock.

The last *Temple* I picked up gave out the familiar choky tone. I hauled the three pieces of the chassis to the shop, replaced the cone, and hooked it up for a pre-delivery test. Then I discovered the fault was an open cathode resistor! In other words—I had thrown away the price of a cone.

This resistor is mounted on the rear wall of the chassis behind the first audio socket. Wire-wound, 2,000 ohms, opened at the end clamp. Costs less than a speaker cone, and can be easily checked with a bridging resistor you know is good. The value required for trial is not critical. If you have no resistors with you, use any low resistance meter between ground and the cathode connection. If you have no meter, put your two hands across these two points—body resistance between two dry hands is close enough to two thousand ohms—but be sure you don't mistake plate for cathode!

On second thought: Perhaps it's better to buy a meter or a resistor, and save your hands for future jobs. If I ever feel I must earn my living with my hands, I'll go back to the farm.

The Reader's Right  
Dear Mr. Ward:  
I agree with you whole-heartedly. Started in business six years ago. Shopped around, but no one would show me anything but catalog sheets. Nevertheless, I jumped into the puddle and bought what I thought I'd need. The scope—for instance—was supposed to have a thousand uses; I'm able to find only five. The way things are run now, we never know WHAT instruments to choose.

The way things stand, I wouldn't buy another instrument if I lost 50% of my trade.

Paul B. Smith,  
Versailles, Kentucky.

Here's a deplorable condition—one which the Serviceman's "College" suggestion (June BENCH NOTES) was intended to correct. On one hand, manufacturers with instruments well worthy of purchase and use; on the other, servicemen turning from the market because information has not been properly presented to them.

Other comment received since the June announcement indicates that other servicemen are in a state which may best be described as one of violent agreement. The response, however, has not come in sufficient volume to warrant furtherance of the idea at the present time.

Sooner or later the profession will establish some proving-ground for equipment, where operating notes and comparisons will be made for the guidance of the repairman-purchaser. Until then, it appears that we servicemen either believe it is better to wait for television to reshape the profes-

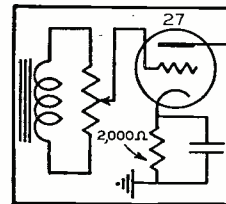

sion, or that the plan to give widely-publicized operating demonstrations of servicing meters is too good to be practicable.

Meanwhile, the above letter proves that something is lacking between instrument manufacturers and servicemen. Whether or not the "college" plan is put into operation, it is certain that some plan is needed. Other ideas might click—how do you feel about it?

(Aside to Mr. Smith: Thanks for the letter. Please pardon the paraphrasing.)

The operating philosophy of many a successful radio store is summarized by Clyde D. Kiebach, Reading, Pennsylvania, serviceman, who says: "I am constantly trying to improve customer relations in order to keep my business on a tomorrow basis."

But he doesn't mean he's sitting back, waiting for television to waft him into professional paradise!

"What can a serviceman do to prepare himself for the advent of television and facsimile?" asks A. L. K. of Hollis, N. Y. "I have been reading M. W. Thompson's RN articles on television, but, while they are informative, I cannot connect his information with my future business set-up."

In a near future issue, BENCH NOTES will treat this subject from a serviceman's angle. In the meantime, Thompson is a good man to follow.

A. H. Davidson, of Damariscotta, Maine, has had calls to modify 110-volt a.c. sets for use on 32-volt d.c. power supplies. The use of a vibrator plate supply has been suggested to him, but no data has been available on one with a 32-volt input winding. He also inquires regarding the changes necessary to operate a 110-volt phono drive motor on the lower d.c. source.

Without knowing all the local factors concerned in such a problem, I believe that it is a good general rule to leave equipment in the combination and function intended by its designers; that, by so doing, greater efficiency results. No matter how efficient a makeshift 32-volt-input vibrator would be, its adaptation would require that both filament and plate wiring would have to be changed—and, in some cases, also tubes. The performance of such revised apparatus would rarely result in set performance which would compare favorably with the original; and the changes would result in an orphan receiver if the customer ever again moved back into an a.c. area.

I believe a better method would be to insert a converter between the old set and the new power supply. No changes would have to be made in the receiver—which would mean that it would operate nearly as well as its manufacturer intended; and also that the set, left intact, would be useful if its owner moved the second time—either to a 110-volt a.c. neighborhood, or one using 32 volts d.c.

Such a converter may be bought on the present market. A wattage rating of 125—one of the available sizes—would permit the set to obtain its plate and filament supplies from the power transformer. This method would be much quicker, efficient; and, even if the customer had to pay a few

dollars more, he would be more than compensated for the extra cost by having satisfactory reception and undisturbed wiring.

Another available converter, rated at 35 watts, could be used to supply high voltages through the set power supply, providing the set filament wiring and tubes were changed; but contemplation of the resulting hybrid—which requires two power sources—is not very appealing, and it wouldn't be to a customer if he understood it, either. Offhand, I imagine there should be quite a market for converters in locations such as yours.

In changing a phono motor over for 32-volt operation, a motor swap would be one feasible plan. I should think, however, that as long as the remainder of the set were being changed over for 32-volt operation by the addition of a converter, that the phono motor should be considered as part of the a.c. load when a wattage rating was being estimated, so that one converter would have sufficient capacity to deliver all the juice the combination required.

One point that should be considered under these conditions is the ability of the 32-volt supply to handle enough input power for the proper operation of the converter. Many of the 32-volt systems I have come across have been chosen for price, with a wattage demand based on what the purchaser thought were his maximum load requirements for all time. Naturally, as the load out of the converter increases, so does the input load; and, because of this, the serviceman should be sure the 32-volt supply can take the gaff. While a phono motor requires little drive power, these little additions become important on an overtaxed supply. If the power supply can stand it, get a larger converter; but if not, and the customer balks when he is told he needs a larger 32-volt system, why bother with him? If he is not interested enough in record music to improve his own equipment, why should you become involved in design engineering that will probably be compared unfavorably with his original rig?

**B**ENJAMIN STIER of Germantown, N. Y., reports: "Customer up here in the hills tunes in Raymond Scott's song *Powerhouse* continually. Says he uses it to charge his battery. Shall I inform the FCC, or the Interstate Commerce Commission?"

Neither. Let him go scotfree. The battery will eventually crack.

**R**AY E. MORROW, Seattle repairman for a large radio dealer, writes: "In my stops at other service shops, I find most of the boys know practically nothing about their equipment. Some say it is no good, and are sincere in thinking so. Sometimes they are too lazy to find out what it is all about."

Why blame the serviceman when he comes of professional age and begins to understand his main earning problem is one of a commercial, not technical, nature? If, for instance, he buys an oscillograph and—without knowing what makes it sweep—operates it only as an arresting window display, is he not more practical than the one who understands its test-bench functions perfectly, but forgets his customer and loads his window with saggy crepe paper and dusty 1926 chokes?

Thanks for the letter, Ray. While I agree with your other opinions, the subjects are too controversial for presentation in this peaceful column.

**M**R. F. LEWIS, serviceman-editor of the *Bulletin*, sends in a copy

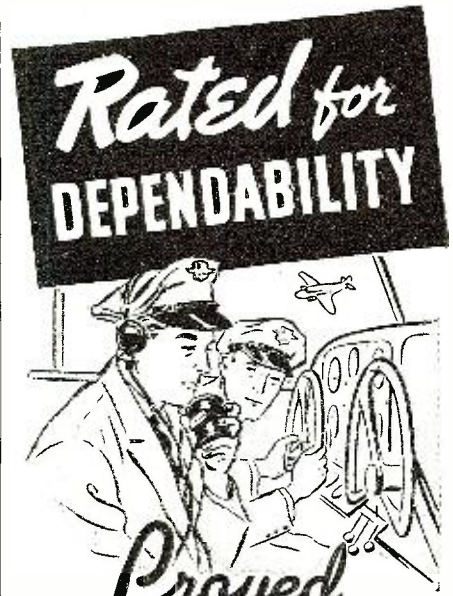

**... Proved IN THE MOST EXACTING APPLICATIONS IN THE WORLD**

Time and again, amateurs report using RCA Transmitting Tubes far above their ratings. "They're a whole lot better than you say they are," some fellows claim. Others ask: "Why don't you raise the ratings?"

The fact is, RCA ratings are *not* based on amateur use, but on hard, constant operation in the world's most exacting applications where tubes are "in action" from 18 to 24 hours a day. Visit commercial broadcasting stations. Look over police and aviation radio equipment. Here you will find RCA Tubes first choice, because the superiority of RCA construction coupled with conservative RCA ratings make them far and away the most dependable.

In proving their superiority on Radio's toughest jobs, RCA Tubes have likewise proved themselves unexcelled for any amateur application you care to name. They last longer. They insure better performance. Rely on them any time—all the time.

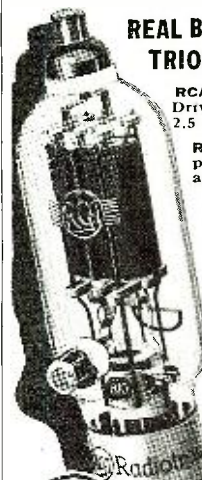

**REAL BUYS in HIGH-QUALITY TRIODES for Every Purpose**

- RCA-809** . . . 55 watts output. Driving power approx. 2.5 watts . . . **\$2.50**
  - RCA-808** . . . 140 watts output.\* Driving power approx. 8-9.5 watts . . . **\$7.75**
  - RCA-810** (illustrated above) 375 watts output.\* Driving power approx. 12 watts . . . **\$13.50**
  - RCA-806** . . . 450 watts output. Driving power approx. 15-20 watts . . . **\$22.00**
- \*Power output as rated conservatively for Class C Telephony

Visit RCA Television Exhibits at the Golden Gate International Exposition and New York World's Fair.

**RCA Radio Tubes**  
 First in Metal, Foremost in Glass, Finest in Performance  
 RCA Manufacturing Co., Inc., Camden, N. J.  
 A Service of the Radio Corporation of America



# BRUSH

## • BJ HEADPHONES

Communications type — light-weight, durable aluminum case—phones encased in molded rubber jackets — good earseal.



Write for your Brush Catalog today.

THE BRUSH DEVELOPMENT CO.  
3312 Perkins Ave. Cleveland, Ohio

## FAST CODE doesn't scare the CANDLER TRAINED OPERATOR!



When you have received your training from Candler fast code can't stump you — you have learned sound consciousness, so that you are reading whole letters and words — copying several words behind with no more strain or effort than is required to read a newspaper.

And you learn code quickly with the Candler system, a few weeks with Candler will bring you more progress than months of undirected practice, because Candler teaches the correct fundamentals. Read the FREE "Book of Facts." Learn how champion operators got their training, how commercial operators won their positions and promotion through Candler Training! Send for your FREE copy today!

### CANDLER SYSTEM CO.

Dept. N-8, Box 331  
Asheville, N. Carolina  
British Address: Room 56, Craven House  
Kingsway, London, W.C.2

## READ AND SEND CODE

Learn Easily at Home  
This Quicker Way

No experience needed. Beginners read code quickly, copy accurately. If already an op. speed up your work with this approved amazing all Electric Master Telex Code Teacher. Only instrument which records your sending in visible dots and dashes on specially prepared paper tape—then sends back your own key work at any speed you wish. Fascinating, foolproof—gets results because you learn by HEARING as well as SEEING. That is why thousands agree this method is strict and quickest. While not designated standard equipment, Telex is used at many U. S. Army Posts, Naval Training Stations. We furnish Complete Course, lend you the New All Electric Master Telex, and personal instruction with a MONEY-BACK GUARANTEE. Low cost, easy terms. Write today for folder R.N.-8, no obligation.

TELEPLEX CO., 67-69 Park Place, New York

In Canada write:

CANADIAN ELECTRONIC INST., TORONTO, ONT.

**of the RADIO**

**EVERYTHING IN RADIO!**

A COMPLETE SOURCE FOR YOUR RADIO NEEDS  
Our immense stock of radio sets, parts and supplies enables you to purchase your entire needs on one order. You will find all your Nationally Known Favorites in this big book which is FREE for the asking. Practically every order is shipped the same day it is received.  
WRITE FOR BIG NEW CATALOG

**BURSTEIN-APPLEBEE CO.**  
1012-14 McGee St. • Kansas City, Mo.

of his sprightly six-page publication—the official organ of the Associated Radio Technicians of British Columbia. It contains news items, reviews of current professional literature, ads and meeting announcements. Thanks and good luck, Mr. Lewis.

—30—

### As I See It!

(Continued from page 10)

be charged to tubes and the difference between their price and the department store or chain store price is explained in the form of personal service.

Is there any real reason why the average shop must charge list price for tubes? The general status of tube sales is such that a price less than list is acceptable. Many servicemen who sell tubes fail to recognize that while many of the stores with which they compete, are selling tubes at 40% off list, the price servicemen pay for tubes is sufficiently low to enable them to sell tubes at 40 off and still not take a loss, providing, that the proper costs are apportioned to the sale of tubes. A tube which is purchased at 50 and 10% off and resold at 40% off list is sold at a mark-up of 33 1/3% on cost. And if by chance, a serviceman can do a selling job and get perhaps 10c or 15c more than the chain or department store by doing a selling job, the mark-up on cost increases to 70% or 80%.

I do not claim that the conditions mentioned exist all over, nor that servicemen can compete in every case, but I do know that many of the servicemen who have discussed this subject with me, as it related to conditions in their own town, did not understand what discounts meant in actual cents per tube and in most cases allocated an excessive amount of operating expense to the tubes sold.

Mind you I am not approving the present chaos in tube merchandising, or am I placing the blame upon the shoulders of the servicing industry. Far from that. But I feel nevertheless that the serviceman who becomes familiar with discounts, mark-up, and the factor associated with the sale of tubes, will learn some very surprising things. It is significant to remember that if losses are being taken in the tube field today, they are being taken primarily by manufacturers and distributors.

The average service shop is not a big seller of tubes and the sooner he learns to place the minimum importance upon tubes as a source of major profit, the better off he will be. If I can say, and I believe that I can make the statement, that 20,000 servicemen in this country are responsible for 85% of the tube sales through their channels, then they sold about 16,000,000 tubes during 1938, or about 800 tubes per man as an average. I know this to be high, but it is still an average. With the average price of the usual run of fast moving tubes somewhere around 70c list, the maximum gross profit

based upon a 50% discount is \$280.00 per year, per man.

I appreciate that every dollar profit counts, that some service shops dispose of a large number of tubes each year, perhaps three or four times this average, but that still does not alter the situation that the average service shop should not place too much importance upon tubes as a primary source of income. If this is fully realized, many shops will find that they can compete in tube sales with other organizations, because tube sales represent just one form of revenue and a small one at that. The other activities of the service shop provide the required revenue.

*An interesting commentary concerning tube sales is that the volume of chain and department stores offering cut prices has been falling during the past few years. This information is secured from good authority.*

### Improvements Upon Chassis

As a rule it is poor policy to recommend that servicemen make changes upon manufactured receiver chassis so as to effect improvements. This is so because the change might be made without full recognition of all of the existing conditions, and, that which might be considered to be an improvement might prove otherwise.

Just recently I received a communication which brought up this point and if it were not for the fact that most of us are creatures of habit and very reluctant to change, this note would not be necessary. My correspondent states that he does a great deal of work upon one manufacturer's receivers and has made permanent records of the exact receiver models owned by his various customers. He uses this information to very excellent advantage as a means of increasing income.

Every so often receiver manufacturers release chassis change data and this gets into the hands of servicemen in one way or another. The person who wrote the letter states that he uses such change data as a means of securing additional business. If he finds that his records show a customer in possession of one of the early model receivers and a change note is found wherein the change is such as to improve operation, he advises his customer that he is in a position to make a change upon that chassis so that it will conform with the last production runs of that receiver and will be improved.

In some cases, the customer is satisfied with what he has, whereas in other cases, the customer is willing to pay for the change, and it is made. The cost to the customer can be mentioned when the call is made, because all information is known.

This is a very interesting application of such change data and illustrates what can be conceived in a mind that is fertile. Here is an example where one man's poison is another man's food. Such change data was originally conceived to provide the solution to certain defects which developed after



a while and to acquaint men who had occasion to work upon the receivers, with what changes had been made in later production runs. This avoided the confusion which would exist when one of the new, changed receivers was compared with the schematic for the original production run. It has become habit to use the data in just this manner. Now along comes a serviceman and does not wait for troubles to develop in order to secure added revenue.

**Taking Things for Granted**

I wonder how many times during the past year you were baffled by the simplest of defects. Only because you took certain things for granted. Suppose that you settle back for a few minutes and let me talk about things which happen in a radio service shop and are by no means technical, yet damned annoying.

For example, I think the soldering iron is on—only to discover after having clipped, scraped and jiggled a wire into a connection that the iron is not hot and the wire comes out of the soldering lug and all of the operations must be repeated because there is no sense in holding the parts of the connection in place while the iron heats.

Then again I need a certain part to finish a job—something that is not very expensive, but just suited for the work at hand. The jobber must have it, so I go there. Shucks, he is just out of stock, but he'll get it.

I hook the oscillator to the set and no signal. Now what in blazes is wrong with this job? It should work, it worked before and nothing could have happened to it. Yes, all the tubes are tight in the socket and the test oscillator is on. The antenna-ground connection is intact, but no soap. After fretting and fuming we discover that the antenna and ground connections of the oscillator are reversed.

In other words, we take things for granted, in fact, too many things for granted and it means a terrific waste of time, but forgetting the time, it means a great deal of annoyance. The simple things can be more annoying than the complicated items because it is only the simple things, the simple defects, that we take for granted. The things we know and understand we take for granted. We always feel that the other person must know them as intimately as we do—because we know them and all of us have become fretful on that account.

Nothing can be taken for granted in a service shop. Any one of ten thousand troubles might develop and the simplest has the same major effect as the most complicated. Being methodical is not equivalent to becoming a machine. It is actually sparing yourself a great deal of aggravation. Of course becoming too methodical might prove annoying to someone else, but your first concern should be yourself.

Life is complex enough as it is without making it worse. Don't for one moment believe that I am callous, cold blooded and methodical. Not by a long

sight. That is why I write these lines. I speak from experience, with perhaps the gift of being able to understand why I am a pain to others at the end of a day. It might appear strange to you as a reader, that I associate the servicing business with being a pain to someone else. I do that because almost every time I take something for granted, I find that I was wrong. It's like looking for something on the top of the pile, you know it is there, you remember having placed it there, in fact you know positively that you saw it there, and then you find it on the very bottom—the absolute depth of the pile.

Never take anything for granted. There ain't no such animal as the man said when he saw the elephant in his vegetable garden.

**He Sleeps So Nicely**

**W**HAT'S wrong with the bird who attends a service meeting and goes to sleep after the first fifteen or twenty minutes? Is it the speaker or the subject or just lack of consideration for the man sitting next to him? Most of these fellows who have become expert lecture-sleepers lean either to the right or to the left and rest their weary heads upon their fellow listeners.

It would not be so bad if the man would remain asleep. Ever so often, he awakens with a start and if the speaker is facing the audience, he sees this head jerk up from no place, and it is very disconcerting to say the least. Of course, if the guy snores, he does not sleep very long before some one pushes in a rib—or at least tries to—not because the sitting trombone is interfering with the speaker, but because the fellow on the adjacent seat does not like the key in which the music is being played.

It's possible, of course, that this man, who finds it very difficult to stay awake, is an outdoor man and suffers from something or other when he is confined in a room with perhaps fifty or one hundred others, or maybe he normally goes to sleep at 8:30, but I doubt it very much. More than likely, it's just that he likes to sleep or does not like to listen to any speaker.

Neither one is so bad if only when he did wake up, and for a moment was strange to his surroundings, he opened both his eyes. As a rule he opens just one, and that only half open, so that when you look at him from the speaker's platform, you don't know if he is winking his eye at you—if something got in his eye and you should offer aid, or if he is scowling for having been awakened before the talk was over.

Sometimes they fool you. Very often you find this head bobbing forward, and you feel happy that there is at least one man in the audience who agrees with you, only to become suddenly disillusioned when you discover that he is awake and no longer agrees with you. . . . Well, "that's the way it goes," as Kay said when she heaved the brick through the window.

**Radio's Biggest P. A. VALUES!**

**18 WATT AMPLIFIER \$19.95**

**GET ALLIED'S SUMMER CATALOG!**

Amazing values now in ALLIED'S Free 164-page Summer catalog! New Sound System for every purpose, 8-65 watts. Over 14,000 parts; radio's biggest line of Record Players, Phonographs, Records; latest Test Equipment; new Amateur gear; dozens of Kits; books, tools, etc.—and 62 new "KNIGHT" Sets, as low as \$5.95—all types, now 3-in-1 Portables, etc. Everything in radio at lowest prices. In ALLIED'S catalog. FREE—send coupon.

**7 NEW PORTABLES**

**ALLIED BOOKS 10c**

**RADIO BUILDERS! P. A. MEN!**

"Radio-Builder's Handbook"—For beginners, tells how to select circuits, read diagrams, make chassis, etc.—only 10c.

"Essentials of Recording"—Complete facts, tips on making records, reproducing, etc.—10c, send coupon.

**FREE CATALOG**

ALLIED Radio Corp., Dept. 1-H-9, 633 Jackson Blvd., Chicago.

Send your Free Radio Catalog.

10c Enclosed—Send Builder's Handbook.

10c Enclosed—Send book on Recording.

Name.....

Address.....

**YOU CAN BECOME A MONEY-MAKING RADIO EXPERT**

WITH THE **NEW SPRAYBERRY**

Personalized **HOME TRAINING in RADIO and TELEVISION**

**You Learn Easily in Your Spare Hours . . . .**

**By Doing Many Experiments with Up-To-Date Equipment**

Here's a really fine, up-to-the-minute Radio and Television Training that's specially designed to give you quick results. **TRAINING PREPARES YOU FOR GOOD RADIO JOBS . . . AT EXCELLENT PAY.** My training starts right at the beginning of Radio . . . unfolds each subject in a simplified, logical, understandable style. You easily learn Television, Electronics, Facsimile Radio, Radio Set Repair and Installation Work, etc.

**NO PREVIOUS EXPERIENCE NEEDED** It makes no difference what your education has been. I can fit you for a good-paying radio job. Your success is my full responsibility.

**YOU GET PROFESSIONAL TEST EQUIPMENT PLUS EXPERIMENTAL OUTFITS**

. . . Includes 110 Radio Parts (to build complete Receiver), Tools, All-Wave, All-Purpose Analyzer, and Experimental Outfits for conducting actual experiments with your own hands.

**I Supply**

**146 RADIO PARTS**

**RADIO TOOLS**

**ALL PURPOSE ANALYZER**

**EARN WHILE YOU LEARN** My **BUSINESS BUILDERS** show you how to put your Equipment to practical use in handling actual money-making Radio Service Jobs shortly, after you begin training.

**SERVICEMEN**

I offer Advanced Training for those already in Radio. Get complete details in my FREE 52-page Book. **The Sprayberry Course is Sold Under a Money-back Agreement**

**RUSH COUPON FOR BIG FREE BOOK**

**SPRAYBERRY ACADEMY OF RADIO**  
F. L. Sprayberry, Pres.  
225-N University Place, N.W.  
Washington, D. C.

Please send me FREE copy of "HOW TO MAKE MONEY IN RADIO."

Name..... Ago.....

Address.....

City..... State.....

Tear off this coupon, mail in envelope or paste on penny postcard. Servicemen—Check here



**Learn RADIO**  
with *Ghirardi's Home-Training Course*  
**COMPLETE IN 7 BIG BOOKS**

Here is your **BIG CHANCE** to get into **RADIO!** This **ONE** handy volume gives you the complete **basic** theory and fundamentals of **Radio, Electricity, Television, Sound and Cathode-Ray Tubes**—the same course used by more radio schools and students than any other radio book in the world. Think of it!—for \$4 you too can thoroughly equip yourself for a lifetime radio career!

**EASY AS A. B. C.**  
It's a pleasure to learn radio this easy way! Everything is made clear and simple—practical short-cuts speed your learning. No math—no previous training necessary!

**36 VOLUMES IN 1—972 PP.—\$08 ILLUS.**  
1. Radio Broadcasting System. 2. Sound, Speech, Music. 3. Electron Theory; Elec. Current. 4. Elec. Units; Ohm's Law; Resistance. 5. Elec. Circuits; Batteries. 6. Magnetism. 7. Electromagnetism. 8. Electromagnetic Induction. 9. Inductance. 10. Capacitance; Condensers. 11. A.C. Circuit. 12. Filters. 13. Measuring Instruments. 14. Radio Waves. 15. Broadcasting. 16. Receiver. 17. Vacuum Tube Principles. 18. Vacuum Tube Characteristics. 19. Vacuum Tube Construction. 20. Vacuum Tube Detector and Amplifier Action. 21. Radio Frequency Amplification. 22. "Meristics." 23. R. F. Amplifiers; Tuning Coils. 24. Audio Amplifiers. 25. Speakers. 26. Battery Operated Receivers. 27. Power-Supply Units. 28. Elec. Receivers. 29. Automobile and Aerial Radio. 30. Picture Pickups; Sound Systems. 31. Short-Wave. 32. Photoelectric Cells; Cathode-Ray Tubes. 33. Television. 34. Antennas and Grounds. 35. Testing, Servicing. 36. Sound Pictures. 366 Self-Review Questions!

**USE IT 5 DAYS—OUR RISK!**  
Yes, if you can part with the book after 5 days, return it and get your money back. No risk—no trouble—just clip the coupon—and mail NOW!

**MAIL COUPON TODAY!**  
Radio & Technical Publishing Co.,  
45 Astor Place, New York, Dept. RN-89.  
 Here is my \$4. Please send **RADIO PHYSICS COURSE** postpaid, with money-back guarantee.  
NAME .....  
ADDRESS .....  
CITY ..... STATE .....

Send free descriptive literature.

**OOPS! SO SORRY!**  
In the diagram appearing at the bottom of page 18 of last month's issue, our draftsman made the error of showing condenser C18 connected at the output side of choke L4, instead of the *input* side. Condenser C18 should connect between *ground* and the *input* of choke L4. To make the actual electrical correction, change the connection of one side of C18, now on one side of choke L4, to the other side of choke L4. To Mr. Berkoff, our sincere apologies, and many thanks for calling this to our attention.—The Editors.

**RADIO PHYSICS COURSE**

(Continued from July issue)

**Radiation resistance:** An antenna of the common type discussed here really forms a condenser. If the antenna were replaced by an air-dielectric condenser having no losses, and having a capacitance equal to that of the antenna, and the circuit were tuned to resonance by an antenna series inductance, it would be found that the current in this circuit is much larger than that obtained at the base of the antenna with the same power input, when the actual antenna itself is used instead of the condenser.

If a non-inductive resistance were now added to the condenser circuit and its resistance adjusted until the antenna current was the same (for the same power input) as before, this value of resistance is called the total *antenna resistance*. The added resistance consumes energy at the same rate as the antenna, and therefore the total effective resistance of the antenna must be equivalent to this resistance added to the antenna circuit. The power consumed in either case is equal to  $I^2R$ , in which I is the current and R is the resistance. Hence the total antenna resistance may be defined as the effective resistance that is numerically equal to the quotient of the average power in the entire antenna circuit divided by the square of the effective current at the point of maximum current.

Of this total energy, part only is radiated away, the remainder being converted into heat in the aerial circuit. Now the effective resistance R may be looked upon as consisting of two separate component resistances, one accounting for the losses in the aerial circuit including radio-frequency resistance of the conductors, ground resistance, insulator leakage, dielectric losses, etc., and the other accounting for the useful power radiated. This latter fictitious resistance is called the *radiation resistance* of the antenna; it is that equivalent resistance which, when multiplied by the square of the antenna current, gives the useful power being radiated. The radiation resistance is used as a measure of the ability of an antenna to radiate power. An antenna with a high radiation resistance is a good radiator and vice versa.

It can be shown that the radiation resistance is proportional to the square of the *effective height* of the aerial,

and to the square of the frequency or inversely proportional to the square of the wavelength. The effective height is not equal to the actual height of the horizontal portion above the ground.  
(To be continued next month)

**RADIO NEWS Transmitter-Receiver**  
(Continued from page 14)

the audio voltage coming from the speech amplifier. It was found that two cells (3V.) gave the proper amount of audio to properly excite the VOX.

**Push-to-talk Feature**

There are certain times when remote control is desirable, either in the same location as the transmitter or possibly in another room. Once a station has been tuned in on the receiver, we may control the entire series of transmission from our easy chair. Most microphone stands do not have the needed space available to mount a push switch. The stand used by the authors was especially built by *Shure Bros.*, and includes their directional *Uniplex* crystal mike.

A directional type microphone is recommended to be used in conjunction with the VOX system. If too high a speaker level is used at the receiver, the VOX relay will operate when it is not wanted and a reduction must be made in speaker volume to reduce the tendency for this to occur. The directional type may, therefore, be used at higher levels without operating the VOX accidentally.

**The Exciter Unit**

Past experience with the electron-coupled means of frequency control dictated that its use be incorporated in the transmitter in addition to crystal control. A *Meissner Signal-Shifter*, with 160 meter coils, is removed from its original cabinet. The leads are extended and shielded and brought down to the exciter panel. The main frequency control dial is controlled by a length of flexible cable made by the *S. S. White Dental Mfg. Co.* The *Signal Shifter* was hung beneath the top of the cabinet by means of machine screws and may be seen in the illustration of the completed unit.

The *Signal-Shifter* is used for operation on all bands where ECO is desired. Crystal control is used on the most used higher frequency bands. These are all of the variable type, and by carefully selecting the proper frequencies, ample coverage may be had within any band used.

In our case we picked frequencies in the 20 meter fone band. Our crystals had to cover 100kc. in the band and so the "rocks" were chosen with frequencies that were consecutive and with the minimum of overlapping; starting with 7080 kc. which becomes 14160-14184, next 7090 which becomes 14180-14204, 3550 kc. which becomes 14200-14224 and finally 7110 which becomes 14220-14244 kc. Thus we cover our whole 14 mc. fone bands with the crystals. *Bliley* and *Monitor* units were used; the *Monitor* being the 80 meter rock,

**Take a Trip to the CITY UNDER THE SEA**

Relax in your easy chair and travel in imagination to a world of entrancing fantasy, bold adventure and fascinating intrigue far beneath the ocean's surface.

Or

Go adventuring into a weird and beautiful valley of danger and romance with the

**GOLDEN GIRL OF KALENDAR**

Just two of the many fascinating lands you can visit in fancy on the magic carpet of fine fiction.

SEPTEMBER ISSUE

**Fantastic ADVENTURES**

On All Newsstands JULY 20

It is absolutely necessary that the top plate of the crystals be at ground potential, and the crystal is so inserted in the holder. Without this precaution, the extended flexible lead will destroy the ability of the rock to oscillate.

The exciter unit was designed with the problem of power consumption first in our minds as only a limited amount could be used in this unit. Several types were used as oscillator tubes and the performance studied. The choice of a 6N7G was made as the two sets of elements could be used as two independent stages at high efficiency.

Due to the vibrations from the many relays and the motor generators, we took extra precautions in the mechanical assembly to guard against any part or lead from working loose. A liberal amount of terminal lug assembly strips was used so that all parts "tied-down" and remained in place. Lock-washers are also under every hex nut. The layout has been shown in the illustrations and should be followed for shortest possible leads. All of the filament transformers are mounted beneath the chassis, while the plate transformer and rectifier tube are mounted above the chassis.

One section of a type 6N7G triode is used as a straight crystal-controlled oscillator when output on the higher frequencies is wanted. This section contains a series of variable crystals and a selector switch so that they may be selected at will from the front of the panel. Four *Amphenol* isolantite sockets are mounted on the chassis directly in back of the front panel and control of the three *Bliley 40 meter* and one *Monitor 80 meter* crystals is made by means of flexible shafts together with the *National* insulated couplings as shown. Stops were made on the holders so that forcing the knob would not damage the crystals.

A 6.3 v. 120 ma. pilot lamp is placed in series with the crystals to ground as a protection to the units and as a means of indicating any overloads in the circuit. The top safe value for most crystals is around 80 to 100 ma. so a normal brilliancy would indicate that too much current were being passed through the crystal.

The same triode section may also be used as a doubler when the *Meissner Signal-Shifter* is used for operation on the lower frequencies. The first grid may also be shorted out when the 160 meter signal from the *Signal Shifter* is fed into the second section to prevent any possibility of the first section having an absorption effect on the active circuits.

The 6N7G crystal tank circuit must be designed so that both the 40 and 80 meter bands may be resonated with the *Hammarlund* condenser shown. This has a maximum capacity of .00014 mfd. The coil is wound with 13 turns of No. 22 DSC wire spaced one diameter. The form is 1½" in diameter, and made by *Hammarlund*. The condenser is mounted within the coil and

controlled from the panel with flexible shafting and insulated couplers.

The second section of the 6N7G is used as a doubler whenever crystal-control is used and does not require any neutralizing in this service. The tank circuit was designed around the *Browning* 5P tuner so that rapid band-change might be had to the doubler section. This plate circuit is series-fed and the variable tank condenser rotor grounded directly at the assembly. The five coils cover the 10 to 160 meter bands and are selected by means of the built-in rotary switch. A *Cutler Hammer* singe-pole-double-throw switch permits the grid to receive its drive from either the signal shifter or from the crystal oscillator. Best performance was had by using 300 volts on the plates of the 6N7G and the crystals operated at low currents. Ample excitation to the following stage is thus provided.

The choice of a second doubler or driver tube was made after an examination of the tube tables and the *Taylor* type T21 was found to provide the needed amount of drive to the final T55 amplifier and did not require neutralizing, either as a straight amplifier or as a doubler. This tube also uses a *Browning* 5P tuner in the plate circuit and the same sequence of coils are selected on the rotary switch. A low C circuit is desirable in any modern amplifier stage for greatest efficiency and is met in the above tuners by using a tuning capacity of 50 mmfd. to cover all coils. This may seem a bit low for the 160 meter band, but was practical as plenty of power was available and a sacrifice in efficiency could be tolerated.

Tuning of the 6N7 sections is made in the conventional manner and resonance is indicated on the grid meter, which is tuned to maximum grid current from the oscillator tube, instead of using the plate current dip method in the plate circuit. In this way, the same meter is used to indicate resonance in the oscillator and also to indicate grid current in the 6N7G doubler stage.

When changing from one band to another it is well to caution the constructor to remove the plate voltage from the transmitter so that the contacts will not burn from the d.c. arc which would be set up if plate current were passing through the switch.

The final stage is unique in its mechanical features and was designed with an eye towards having extremely short leads to add to the efficiency of band-switching where more than the usual amount of space must be taken by the coil assembly. The *Taylor* T55 tube is mounted on angle brackets underneath the chassis with the plate cap placed in the position shown. The plate must be mounted in the "on-edge" position so that the filament will not sag and cause a short to occur to the grid. Ventilation is provided by cutting a hole in the shelf directly under the position which will be occupied by the tube after its insertion into the



E. H. RIETZKE

PRES. OF CREI

● You can Laugh at the other fellow if you have the training that leads to better pay!

CREI technical training is the first step to more money and a real radio future

Here is the opportunity for you to train yourself for a better job in Radio and Television—at home in your spare time. CREI has trained thousands of men for important positions in broadcasting, aviation, marine and police radio. Constant improvements demand better men to have the important jobs—and that means a better job for YOU if you train NOW!

Practical Radio Engineering in 3 study plans: Home-Study—Residence Course (begins Sept. 13)—Summer Residence Television Course—in combination with regular Residence or Home-Study Courses.

Write for the CREI "TESTED PLAN"

Sent free on request. Answers all questions about yourself and your future. Fully illustrated and crammed with information. Write for your copy now.

CAPITOL RADIO Engineering Institute



COUPON — mail it today!

CAPITOL RADIO ENGINEERING INSTITUTE  
Dept. RN8, 3224—16th St. N. W., Wash., D. C.

Please send me your booklet "A Tested Plan for a Future in Practical Radio and Television Engineering." I am interested in the course checked:

Home Study Course.  1-Yr. Residence Course.

Name..... Age.....

Address.....

City..... State.....

NATIONAL UNION  
Radio Tubes



TOP  
AWARD  
1929-1939

BEST PROPOSITION  
for the  
SERVICE PROFESSION!  
WRITE FOR DETAILS  
NATIONAL UNION RADIO CORP.  
NEWARK, NEW JERSEY



cabinet. Another hole is cut or punched in the rear side of the chassis so that the heat will have a chance to escape from under the chassis.

The split stator tank condenser, *Cardwell*, has a capacity of 100 mmfd. per section and affords a good LC ratio on the frequencies most used. A *Cardwell* type *JD-80-OS* is mounted within the 160 meter coil permanently. The assembly is the *Barker & Williamson* turret which consists of a substantial coil mounting and a low-loss isolantite switch for selection of the coils. Three coils may be mounted in the turret to cover the bands most desired. Center links are used to couple the output to the antenna system through the relay which mounts up in the top corner of the cabinet.

The T55 amplifier is used straight through on all frequencies if desired and is plate neutralized in the conventional manner. The plate voltage may be set by means of the autotransformer which reduces the input line volts to the primary of the high-voltage transformer. This feature is highly worth while for initial tuning adjustments as well as for a means of controlling the input to the transmitter.

Two *Guardian* relays offer protection to the rig, an overload to prevent off-resonant surges from damaging the tubes, and an underload to prevent plate voltage application to the modulators in case the T55 is not in operation. If the latter condition were permitted to exist, the secondary of the modulation transformer would be feeding an unloaded circuit and this no-load condition could seriously damage the transformer. This relay should be

adjusted to close the contacts when about 75 ma. of current is drawn by the T55.

All of the filament transformers are mounted under the chassis as shown. Separate leads to all input circuits are provided so that the current demand may be distributed to the various generators for d.c. operation. The plate input is controlled from a separate source and is arranged to turn on when the other supplies receive their primary power.

#### Operating Procedure

Five band operation is had in the following manner: For 160 meters the *Meissner Signal-Shifter* operates with its complete set of 160 meter coils. This output feeds the second section of the 6N7G and this tube is resonated by selecting the 160 meter coil and by tuning to resonance. The T21 operates as a straight amplifier and drives the T55, also as a straight amplifier on selection of the proper coil in the turret.

For 80 meter output, the *Signal Shifter* is also used on 160 and the crystal selector switch set to the grounded position to prevent unwanted absorption. The second 6N7G section is tuned to 80 meters as a doubler, while the remaining tank circuits are tuned to 80 meter output by selecting the proper coils.

For 40 meter output, either the *Signal Shifter* or crystal-control may be used. For the former method—the SS operates at 160, doubles in the 6N7G to 80, doubles to 40 in the T21 and drives the final straight through on 40 meters. For operation from crystal, the selector switch to the T21 is set to the proper position, an 80 meter "rock" selected by the crystal switch and the oscillator tank tuned to the 80 meter fundamental. The second section is tuned to 40 meters and the remainder of the unit operates as stated for a.c. operation.

For 20 meter output, both above methods may be used. For *Signal Shifter* drive the switches are set as for 40 and the transmitter operates as follows: 160 meter output from the *Signal Shifter*, quadrupling to 40 in the 6N7 stage, doubling to 20 in the T21 and driving the amplifier on 20 meter fundamental. Crystal control is had by setting the switches and by selecting one of either 40 or 80 meter crystals and tuning the oscillator tank to resonance. For the 40 meter unit, the second section is set to 20 meters and the rest of the rig operates as a straight amplifier. With an 80 meter crystal, the second section tunes to 40 meters, doubles in the T21 and 20 and drives the T55 as a straight amplifier.

For 10 meter operation, a 40 meter crystal is used, the 6N7G doubler tuned to 20 meter output, the T21 to 10 meters and again the T55 operates as a straight amplifier.

It will be seen from the above that in all cases, operation is had by operating the modulated stage as a straight amplifier and never as a modulated

doubler. In all applications, the second section of the 6N7G is used as a doubler when crystal control is used, and for that reason does not require a neutralizing circuit.

The T55 amplifier is supplied with fixed bias in addition to grid-leak bias to add to the ease of tuning as well as to provide a current limiting medium to the tube in case a misadjustment were made in the preceding stage. This is done by constructing a simple low voltage supply in connection with an 84 rectifier. Filtering may be had with a suitable resistor in place of the conventional choke as the current drawn by the tube is only minute.

So far we have discussed the general construction and tuning of the complete transmitter and have attempted to give the reader some idea of the versatility of the units. While space does not permit a complete picture to be given as to individually building all of the sections, we shall, in the next article, show the complete control circuits, together with a full page schematic diagram of the entire transmitter-receiver for the serious-minded builder to follow in order to obtain the results had on the original model. Inasmuch as one or all of the features may be added to existing transmitters, we feel that a close analysis of the schematic will solve many of the problems that have presented themselves to constructors of modern equipment. —30—

### Short Wave Flashes

(Continued from page 42)

(21.53), GSH (21.47), GSV (to 8:45 a.m.), (17.81), GSG (17.79), GSF (15.14), and GSB; Trans. 3, from 9 to noon, over GSH, GSV, GSG, GSF and GSB; Trans. 4, from 12:25 to 4 p.m., over GSG, GSP (15.31) (from 1:15 p.m.), GSI (to 1:45 p.m.), GSD, GRX (9.69), GSC (9.58) (from 1:30 p.m.), and GSA (6.05), from 4:20 to 6 p.m., over GSP, GSO (15.18), GSF, GSD, GRX, GSC and GSA; Trans. 5, from 6:20 to 8:30 p.m., over GSO, GSD and GSB; Trans. 6, from 9:20 to 11:30 p.m., over GSD, GSC and GSB.

FRANCE—TPB12 (11.885), Paris, transmits to South America, daily from 6 to 8:15 a.m. and TPB11 (11.885), transmits to North America, daily from 8:30 to 11 p.m.

J.A.V.A.—YDA (7.25) and YDB (15.31), operate daily except Saturdays from 10:30 p.m. to 2 a.m. and on Saturdays from 7:20 p.m. to 2 a.m.

SWITZERLAND—The Monday evening 6:45 to 8:15 p.m. broadcast for North America, is now being heard over HBO (11.402), HBJ (14.535) and occasionally the new Schwarzenburg station operating on 9.535.

TAHITI—According to A. Tuff of London, England, FOSAA (7.1), Papeete, now operates Saturday mornings only from 12:01 to 3:30 a.m.

UNITED STATES—W2NE of New York City, N. Y., operates as follows: on 17.83, Mondays through Fridays, from 6:30 to 9 a.m. and on Saturdays and Sundays from 7 to 11 a.m., also Mondays through Fridays, from noon to 5 p.m. and on Saturdays and Sundays, from 11:30 a.m. to 5 p.m.; on 15.27, daily from 5:30 to 7:30 p.m.; on 11.83, daily from 8 to 10:30 p.m. and on 6.12, daily from 11 p.m. to 12 midnight . . . W3XAU, Philadelphia, Pa., operates as follows: on 15.27, weekdays from 10:45 to 11:45 a.m., Mondays through Fridays, from 12:30 to 5:15 p.m., Saturdays from noon to 5:15 p.m. and on Sundays, from noon to 5 p.m.; on

### RADIO COURSES

New Fall Classes Start in September

RADIO OPERATING—BROADCASTING

• RADIO SERVICING—a practical course

• RADIO AMATEUR CODE • TELEVISION

• ELECTRONICS—1 yr. day course, 2 yrs. eve.

Day and Evening Classes. Booklet Upon Request.

New York Y. M. C. A. Schools

7 W. 63rd St. New York City

### RADIO ENGINEERING DEGREE IN 2 YEARS

Intensive, specialized course, including strong basis in mathematics and electrical engineering, and advanced Radio Theory and Design. Modern laboratory, thorough instruction. Low tuition. Self-help opportunities. Also 2-year courses in Aeronautical, Chemical, Civil, Electrical and Mechanical Engineering. Enter Sept. 5, Dec., March, June. Catalog.

INDIANA TECHNICAL COLLEGE

247-A East Washington Blvd., Fort Wayne, Ind.

### RADIO ENGINEERING

RCA Institutes offer an intensive course of high standard embracing all phases of Radio and Television. Practical training with modern equipment at New York and Chicago schools. Also specialized courses and Home Study Courses under "No obligation" plan. Catalog Dept. R.N.39.

RCA INSTITUTES, Inc.

A Radio Corporation of America Service

75 Varick St., New York 1154 Merchandise Mart, Chicago



**PHOTO ENLARGER \$5.94**

Money back guarantee  
A REAL Photo Enlarger that does fine work. Focuses automatically. Also COPIES and has a Contact Printer and Retouching Table. Interesting circular free. Only \$5.94 complete. Lens included.

IDEAL-H, 148 West 23rd St., New York City



9.59, Mondays and Thursdays, from 5:30 to 6:15 and from 6:30 to 10:30 p.m. and on Saturdays from 5:30 to 6 and from 6:30 to 9:45 p.m., and on 6.06, Mondays and Thursdays, from 11 p.m. to Midnight, Tuesdays from 6:30 to 10 and from 11 p.m. to midnight, Wednesdays and Fridays, from 6:30 to 10 and from 10:30 p.m. to midnight, Saturdays, from 10 p.m. to 1 a.m. and on Sundays, from 6:30 to 10 and from 10:30 p.m. to midnight. W8XAL (6.06), Cincinnati, Ohio, is now operating as follows: Sundays, from 8 a.m. to 6:30 p.m., Mondays and Thursdays, from 5:45 a.m. to 2 a.m., Tuesdays, Wednesdays and Fridays, from 5:45 a.m. to 5:30 p.m., Saturdays, from 5:45 a.m. to 11 p.m. and on Sundays, Tuesdays, Wednesdays and Fridays, from 11 p.m. to 2 a.m.

**VATICAN CITY**—HVJ, "Radio Vaticano," operates as follows: on 15.12, Sundays, from 2 to 2:30 p.m. and on Tuesdays, from 6:30 to 7 and from 10:30 to 11 a.m.; on 9.66, Wednesdays, from 2:30 to 3 p.m. and on Sundays from 5 to 5:30 a.m.; on 6.03, daily except Sundays, from 2 to 2:30 p.m., from 2:30 to 3 p.m., and on Mondays, Wednesdays, Thursdays and Saturdays, from 3 to 3:30 p.m.

**Frequency Changes**

**AUSTRALIA**—9MI, M.V. Kanimbla, to 6.055.

**CHINA**—XMHA, Shanghai, to 11.855; XGOY, Chungking, to 11.89, where it operates from 5:55 to 10:30 a.m.

**COLOMBIA**—HJ1ABP, Cartagena, to 4.924.

**COSTA RICA**—TIPG, San Jose, to 9.612.

**CUBA**—COBX, now varies from 9.205 to 9.10. COCM, Havana, to 9.815; COCQ to 8.85.

**DOMINICAN REPUBLIC**—HI1J, San Pedro, to 5.89.

**ECUADOR**—HC2CW, Guayaquil, to 9.124; HC2ET, "Radio Telegrafico," Guayaquil, to 9.188.

**FRENCH INDO-CHINA**—"Radio Saigon" to 11.78, where it is being heard daily from 7:30 to 10 a.m.

**GUATEMALA**—TGWB, Guatemala City, Guatemala, to 6.49.

**HAWAII**—HI12S to 5.98; HI3W to 9.785.

**IRAQ**—HNF, Baghdad, to 9.685, where it is heard to 3 p.m. with English announcements.

**PANAMA**—IIP5J, Panama City, a consistent frequency jumper, is now being heard near 9.61 again.

**STRAITS SETTLEMENTS**—ZHP, Singapore, back to 9.69 again.

**TAIWAN**—JFO, Taihoku, to 9.68, where it is being heard daily from 9:15 to 10:15 a.m. or later.

**U.S.S.R.**—RKI, Moscow, to 15.04.

**VENEZUELA**—YV5RJ, now YV5RY, to 4.79.

**Data**

**AZORES**—CT2AJ (4), verifies promptly with a letter in English.

**ANGOLA**—CR6AA, Lobito, broadcasts Mondays, Wednesdays and Saturdays, from 2:30 to 4:30 p.m. on 7.614 and irregularly on 7.614.

**BHIMAS**—According to a verification received by Larry Lundberg of Minneapolis, Minn., ZNS (6.09), power 200 watts, relays broadcast band station ZNS (790 kes.), daily from 1:30 to 2 and from 8 to 9 p.m. The opening signal is St. Margarets chimes or Big Ben. The signature selection is "God Save the King." Reports are welcome and these should be sent to K. P. Brown, Secretary of Broadcasting, Office of the Director of Telecommunications, East Street, Nassau, Bahamas.

**BEIGIAN CONGO**—"Radio Leo" the only station in the colony, increased its power recently to 250 watts and now broadcasts on 15.17 and 9.525, Sundays and holidays, from 5:25 to 7 a.m. Reports should be sent to The Catholic Society of Jesus, 7 Avenue Lippens, Leopoldville. . . .

**BRAZIL**—"Radio Bras," which operates as PPU on 19.26, PPQ on 11.67, PPH on 11.93, PPM on 10.31, and PPS on 19.97, is owned by Cia Radio Telegraphica Brasileira, Avenida Rio Branco, Caixa Postal 500, Rio de Janeiro. The QSL card pictures the harbor of Rio de Janeiro and the antenna masts of "Radio Bras" in the foreground.

**BURMA**—J. E. Gardner of Cleveland,

Ohio, writes that XYZ (6.007), 1500 watts, and XZZ (3.488), 50 watts, operate weekdays from 6:30 to 10 a.m. and from 9 to 11:30 p.m. and on Sundays from 9:30 to 11:30 p.m. Correspondence should be sent to, The Officer-in-Charge, Burma Independent Wireless Sub-Division, Strand Road, Rangoon.

**CHINA**—XGOY (11.9), Chungking, operates daily from 7 to 11:45 a.m. and from 4 to 6:30 p.m.; news in English at 9 a.m. and 6 p.m.; news in German at 4:50 p.m. and in French at 5:15 p.m. XPSA (7.01), The Kweichow Broadcasting Station, Kweichang, broadcasts from 5:30 to 11 a.m., with a rebroadcast of XGOY from 8:45 to 9:25 a.m. Power is 10,000 watts.

**COSTA RICA**—TIPG (9.612), operates evenings from 5 to 11 p.m. On Saturday nights an English program known as the "Hour of Costa Rica" is presented at 9 p.m. Reports should be sent to Apartado 225, San Jose. The verification pictures the station transmitter and a pictorial view.

**CURACAO**—IJC1 issues a verification printed in four languages on about the poorest grade of paper imaginable.

**ETHIOPIA** (I.E.A.)—Harold Amers of Pomona, California, writes that IABA of Addis Abeba, is particularly anxious to have dx'ers listen to their complete opera broadcast Thursdays at 11 a.m. or to the Italian songs featured on Fridays at 11 a.m. Reports can be sent either to the E.I.A.R., Ente Italiano Audizioni Radiofoniche, Addis Abeba, to the Minister of Marine, at Rome, Italy.

**FINLAND**—The short-wave station at Lahti is broadcasting at present as follows: over OFE (11.78), from 1:05 a.m. to 12:05 p.m. and on OFD (9.5), from 12:15 to 5 p.m.; over OIE (15.19), from 1:05 a.m. to 4, and from 9 a.m. to 5 p.m., and over OIH (17.8), from 4 to 9 a.m.

**FRENCH INDO-CHINA**—Ashley Walcott

**RADIO ENGINEERING**

• Complete Radio Engineering course in 96 weeks. Bachelor of Science Degree.

DEGREE IN 2 YEARS



Radio (television, talking pictures and the vast electronic field) offers unusual opportunities for trained radio engineers. Tri-State graduates in Radio Engineering can complete the Electrical course in 24 weeks. Courses also in Civil, Electrical, Mechanical, Chemical, Aeronautical Engineering; Business Administration and Accounting. Also short diploma courses (36 weeks) in Surveying and Drafting. Tuition, living costs low. World-famous for technical two-year courses. Special Preparatory Department for those who lack required high school work. Students from all parts of the world. 56th year. Enter September, January, March, June. Write for catalog. *Burton Handy, Pres.*

1689 COLLEGE AVE. ANGOLA, IND.

**TRI-STATE COLLEGE**

**RADIO NEWS**  
\$1.50 per year.

**READY SOON! RESERVE YOUR COPY!**

**RUSH 3¢ FOR 60¢** **604 PAGE CATALOG of AMAZING NOVELTIES!**

NEW, LARGER EDITION! OUR BOOK OF THE YEAR!

Nothing else quite like it. Articles more interesting than a world's fair! Over 600 pages packed full of pictures and descriptions of odd items from all parts of the world—amusing, entertaining and useful articles, some of which you never knew existed—hundreds of items not sold in stores—dozens of things you've always wanted but never knew where to find. They're all in this amazing NEW catalog. Latest radio and hobby kits, newest styles of candid type cameras, fortune tellers, guns and rifles, sporting goods, books, records, etc., etc. in fact thousands of all the latest novelties, many unobtainable elsewhere.

**Put Real "Life" Into Your Next Party**

Go thru your catalog when it arrives. Pick out a half dozen fun makers and put them to work at your party. "BINGO" shooters placed under telephones, plates, etc., explode violently but harmlessly. Auto Bomb, "Electric" Hand Shaker and Tickler, Trick Cards, etc., etc.

**This Gives You Some Idea What The Book Contains**

AIR PISTOLS	NOVELTY CLOCKS	MUSCLE DEVELOPERS
CHAMELEONS	HUNTING KNIVES	SECRET MONEY BELTS
BAROMETERS	SYMBOL JEWELRY	BOOKS ON MYSTICISM
PRESS CARDS	ELECTRIC TRAINS	LATEST STYLE RADIOS
NOVEL RINGS	ELECTRIC TOASTERS	NEW AUTO NOVELTIES
COIN CHECKS	ELECTRO-PLATES	BIG BANG RIFLES
MICROSCOPES	GAMES OF CHANCE	NEW CANDID CAMERAS
ELECTRIC EYE	FORTUNE TELLERS	READ THE MAGIC CARDS
MAGIC TRICKS	OVER 300 4¢ BOOKS	MARRIAGE LICENSE 10¢
LIVE ANIMALS	BOOKS FOR LADIES	ROOBYE MAKEUP KIT
ARCHERY SETS	FISHING SUPPLIES	PORTABLE RADIOS, 5¢ UP
TRICKS	RADIOS & SUPPLIES	ELECTRIC BASEBALL GAME
FIELD CLASSES	PROJECTORS & FILM	LATEST MODEL AIRPLANES
TURBINE ENGINES	WELDING MACHINES	BOOKS ON PSYCHOLOGUES
SKELETON KEYS	TRICKS & GAMES	WEIRD & MYSTIC ARTICLES
TRICKS	RELIGIOUS ARTICLES	PSYCHIC ARTICLES
35¢ TYPEWRITER	OFFICE TRICK SAVERS	SPIRITUALISTIC NOVELTIES
BANKS & VAULTS	15¢ TELEGRAPH SETS	NOVEL BICYCLE ORNAMENTS
SPORTING GOODS		USEFUL SMOKERS NOVELTIES

**just 3 of the AMAZING NEW NOVELTIES**

**30 Shot B-B Pistol**

Automatic repeating action. Pull it up and fire. The shot zip, zip, zip, one right after the other, loads and shoots standard 11's. Swell for target shooting, in country, etc. Sturdy construction, automatic repeater, loads 30 shot, 25¢.

PRICE POSTPAID ONLY 25¢  
Tube of Corescovered BB's 10¢.

**Electric Phones 59¢**

Completely electric, 2 way phones. One tube regular price, full size. Only 1000 sets available at this special price. Guaranteed to battery, and they're ready to talk. ON & OFF switch. Batteries not supplied. One price up to both feet. Speaker and receiver in each unit. Can be used between rooms, houses, etc. Also, etc., etc. 59¢.

factured to sell for over 100¢. Operates on 4 volts. SET OF 2 PHONES

**Folding Camera 39¢**

Stupendous low priced camera for ordinary snapshots. Turns back and slides at back as well as view finder, giving you complete view of subject, as it will appear. Loads each film separately. No waiting to develop. Uses low priced, more saving film. 3 1/2" high. Lens real. Focus up to 100 feet. Pocket size. Loads each film individually. Black finish. Leatherette handle. Take Pictures when least expected—they're with 2 films. PRICE ONLY 39¢ + Extra Films 10¢.

**Pay Only 1-10th of the Actual Cost — We Pay The Rest**

Send just 3¢ for 25¢ for De Luxe cloth bound edition and our new catalog will be sent you as soon as ready. Specially to eliminate the curious we are compelled to make this small charge—actually only 1-10th of our cost! A great big mammoth catalog of 604 pages—rotogravure section—6 color cover—7000 amazing novelties—over 4000 illustrations! Send 3¢ in any convenient form—unused U.S. postage stamps accepted—and we will do the rest! Use coupon below so you be sure to get the new, 1940 edition! Now on the press.

**DE LUXE EDITION 25¢**  
Many want our catalog in a permanent binding for their library shelves. For them we have prepared the De Luxe Edition with a beautiful maroon cloth binding which will be mailed you for 25 cents.

**Reserve a Copy of Your 1940 CATALOG for me—Here's my 3¢**

Send Coin  ONE CENT  or Stamp

**Johnson Smith & Co., Department 393, Detroit, Michigan**

Here's 3¢. Rush your NEW Fall and Winter CATALOG. Be sure I get one of the first copies! (De Luxe cloth bound edition, 25¢.)

Name \_\_\_\_\_ Address \_\_\_\_\_



# RAD O plus

## TELEVISION

—mastered by pre-tested Training

No matter where you are or what you do, National has a complete training plan for you—to fit your circumstances. National's plan is for those seeking immediate shop-training as well as for those who cannot give up present employment and income. Mail coupon below. Find out how you can get the finest in radio and television training.



### NATIONAL SCHOOLS

NATIONAL SCHOOLS, Dept. 8RN  
4000 So. Figueroa St., Los Angeles, Calif.

Please send free Radio and Television Booklet.

NAME \_\_\_\_\_ AGE \_\_\_\_\_  
ADDRESS \_\_\_\_\_  
CITY \_\_\_\_\_ STATE \_\_\_\_\_

**LES** Correspondence Courses in  
**RADIO and ELECTRICAL ENGINEERING**

**ELECTRICAL ENGINEERING** Get good grasp of wide electrical field. Prepare yourself at Low Cost, for secure future. Modern course. So simplified anyone can understand quickly.

**RADIO ENGINEERING** Extra fine course in radio. Public address, photo-electric work.

Trains you to be super-service man, real vacuum-tube technician. Experimental kits furnished. Diploma on completion.

Either course, only \$25. Deferred payment plan available. Write for free copies of school catalogues, student magazines, full details: **SEND NOW!**

**LOWAS \$25**

**LINCOLN ENGINEERING SCHOOL, Box 931-R 8, Lincoln, Nebr.**

**See**

**WOODSTOCK**

**TYPEWRITERS**

## OCEAN FLYERS LOST!

### DOWN ON UNKNOWN PACIFIC ISLE

Weak Radio Signals Tell Amazing Story of Strange Metal Beast Stalking Flyers Night and Day.

Via Short Wave Radio: Welford and MacGlennon, Pacific flyers, have been forced down on an unknown island, no location given, and are menaced by a strange beast they call "The Walker". Radio signals still coming through tell an incredible story. More later.

Don't Fail to Read the Complete Story of This Amazing Aerial Adventure.

## BEAST of the ISLAND

By ALEXANDER M. PHILLIPS

plus other fine stories in

**AMAZING**

**STORIES**

September Issue Now On Sale

of San Francisco, California, informs me that "Radio Saigon." P. O. Box 412, Saigon, operates daily on 6.116 to about 8:30 a.m. and then shifts to 11.84, where it broadcasts to 9:30 a.m. "Radio Saigon" is also operating a second transmitter on 9.49, in parallel with the above mentioned transmitter. English programs are broadcast from 5:15 to 5:30 a.m. and from 9 to 9:15 p.m.

**GADELOUPE**—FGSAH (7.44), "Radio Guadeloupe," is now issuing attractive white QSL cards having red and blue diagonal stripes, with a globe of the world in the upper left hand corner. The picture of a native girl is usually enclosed with the verification. The power of the station is 100 watts.

**ITALY**—The Imperial Short-Wave Center at Santa Palomba, near Rome, consists of 2 100,000 watt transmitters operating as 2RO3 on 9.635; 1 50,000 watt station operating as 2RO4 on 11.81; 2 50,000 watt stations operating as 2RO8 on 17.82, and a 50,000 watt station operating as 2RO6 on 15.3.

**LITHUANIA**—According to a verification received by Carl Weber of Camden, N. J., LYR (9.285), Lithuanian Trumpjuju bangu stotis, Kaunas, has a power of 500 watts. The QSL card is red and white with a view of Kaunas on the front.

**MADEIRA**—CT3AQ (4), "Eddystone," owned by Gabriel Ornelas de Funchal, operates Mondays, Wednesdays and Fridays from 2 to 4:30 p.m.

**MANCHOUKUO**—JDY (9.925), is issuing a new red and white QSL card with the call in black. A Japanese sailboat is depicted in the lower right hand corner.

**MEXICO**—H. Amers of Pomona, Calif., reports that XEYU (9.6), "Radio Universidad Nacional," Servicio de Radiodifusion, Calle De Justo Sierra 16, Mexico D.F., issues an attractive white and grey QSL card picturing a map of Mexico, with an aerial tower pointing skyward from the point representing Mexico City. According to the I.R.M., XEXA (6.175), operated by the Department of Education, Mexico D.F., operates daily from 8 to 11 a.m., from 2:30 to 4 and from 7:30 p.m. to 12:45 a.m. An English hour is broadcast Fridays at 11 p.m.

**NORWAY**—LCL (8.025) is heard irregularly in parallel with LLG. The latter operates at present from 3 to 6 p.m. only. Reports should be sent to the Administration of Telegraphs, Radio Department, Broadcast Division, Oslo, Norway.

**ROUMANIA**—According to Egyptian Radio, a Bucharest station on 9.2, is operating daily from 4 p.m. onward, with the news in English at 4:45 p.m.

**SUMATRA**—YDX (7.21), operates from 5:30 to 7:45 a.m. and from 10 p.m. to 1:30 a.m., while YDX (4.855) operates from 10 a.m. to noon. Reports on the 5:30 to 7:45 a.m. program are verified direct from Medan, the other programs by the usual card from Batavia, Java, headquarters of the N.I.R.O.M. network.

**TRIPOLI**—IQN (9.46) verified on an ICK QSL card from the Ministero Della Marina, Rome, with the call and frequency of IQN typed in.

**URUGUAY**—According to an official list from Uruguay, the following frequencies and calls have been assigned short-wave stations in this country: CXA1 (11.945), CXA2 (6), CXA3 (6.075), CXA4 (6.125), CXA5 (9.485), CXA6 (9.55), CXA7 (11.735), CXA8 (9.625), CXA9 (9.44), CXA10 (11.895), CXA11 (5.92), CXA12 (11.945), CXA13 (6.155), CXA14 (15.16), CXA15 (9.735), CXA16 (15.38), CXA17 (17.8), CXA18 (15.3), CXA19 (11.695), CXA20 (9.7), CXA21 (26.50), CXA22 (29.5), CXA23 (43.5) and CXA24 (5.8).

**VENEZUELA**—Most of the Venezuelan stations are now operating on or close to their new official frequencies in the 62-meter band. On the last check YV6RU, Bolivar, was still operating on 5.9. YV1RO (4.78), Trujillo, is under construction.

### Ultra-High Frequency

Watch the entire UHF for "short skip" during July.

**ITALY**—The E.I.A.R. has inaugurated a 1600 watt station to operate on 43.8, atop a high tower near Milan.

**UNITED STATES**—WCNY (41.1), non-commercial, educational station, is testing irregularly from the Brooklyn Technical

High School. The 31.6 mcs. (9 meter) stations are now applying for moves to either the seven or eleven meter bands, in conformity with a new ruling of the F.C.C. W2XUP of New York City, will go to 25.25; W2XJ of New York City, will go to 25.3; W2XDG of Bound Brook, N. J., will go to 42.1 and W2XHG of New York City, will go to 42.26. The Stromberg-Carlson Telephone Mfg. Co. of Rochester, N. Y., have applied for a construction permit for a 2000 watt UHF broadcast station to operate on the 7 meter band. The Travelers Broadcasting Service Corporation of Hartford, Conn., have applied for a construction permit for a 1000 watt UHF broadcast station to operate on the same band.

### Amateur Reception Notes

**AZORES**—CT2BP (14.14), has been heard frequently of late between 8 and 10 p.m.

**BELGIAN CONGO**—OQ5ZZ (14.318 and 14.36), the Gatti-Expedition in the jungles, is being heard on the East Coast of the United States at various times between 3 and 8 p.m. Reports should be sent to The Gatti Expedition, Leopoldville, Belgian Congo.

**BOLIVIA**—According to an announcement heard over CP1AA (14.29), this station now has a new owner and the QRA was given as "The Observatory," La Paz.

**CANTON ISLAND**—KF6DHW (14.38), verified with an attractive red and white card with silver call letters, mailed from Honolulu. The operator on Canton Island now is KF6PMO. This latter station has been heard on 8.1, at 3 a.m.

**CHINA**—According to W6ITH, XUSRM, P. O. Box 685, Shanghai, QSL'd with a card which was mailed from Victoria, B. C.

**COCOS ISLAND**—Birley Ross of the Newark News Radio Club, was fortunate enough to verify ZC2OP of last year's Cocos Island treasure hunting expedition. The card was from Captain Charles Wilkens, of the M.S. San Pedro, Puntarenas, Costa Rica. The captain stated they did not find the treasure.

**CUBA**—The New U. S. Navy prefix for Cuba is NY4-, thus COSYB becomes NY4AB.

**FRANCE**—French amateurs are forbidden to contact nearly 30 countries, including Italy, Yugoslavia, Roumania, Siam, China and Southern Rhodesia. Any F contacting these countries will have his license suspended immediately.

**HONG KONG**—VS6BE QSL'd in four months for Murray Slopoff of Alleghany, N. Y. He stated he had never contacted a W on fone and that his report was the first assurance that his signals were reaching the United States.

**MADEIRA**—Roger Legge of Binghamton, N. Y., reports amateur CT3AN (7.1), power 100 watts, verified promptly with a white card having red call letters.

**NIGERIA**—The Newark News Radio Club informs me that ZD2H, in reply to a report, stated he operates only on CW and that his call is being bootlegged by a South African ham on 20 meter phone. ZD2H recently moved from Nigeria to British Cameroons.

**NETHERLANDS (DUTCH) NEW GUINEA**—The flying boat "Guba" equipped with a 100 watt transmitter which can operate on 3.105, 6.21 and 12.42, was scheduled to leave Hollandia (accompanied by PK6XX), on June 15, for the return trip to New York, via Australia, Africa and the Virgin Islands. PK6XX was heard telling amateurs recently to send their QSL's to the American Museum of Natural History at New York City, and he would QSL all when he returned.

**ST. VINCENT**—VP2SA (14.216), 120 watts, recently heard from 10 to 11 p.m., stated he does not operate on 20 meters often due to the QRM. He usually is on 7.108. The QRA is Box 73, Kingston, St. Vincent, B. W. I.

**SWITZERLAND**—HB9S (7.255), a new Swiss ham, may sometimes be heard on Sundays near 3 a.m., testing with phonograph recordings.

**UNITED STATES**—Wilson E. Burgess, amateur of Westerly, Rhode Island, has been selected for the William S. Paley Radio Award for 1938. Selection of Burgess was based on his heroic performance during the hurricane which devastated large sections of that part of New England. Foreseeing possibility of an emergency, Burgess assembled



### NOTES ON THE LINDBERG TUBE TESTER

Adapters are available for the new loctal tubes or they can be made by anyone who has built the tester by using a loctal socket and a "G" type base. Refer to base charts for internal connections of the loctal tubes. The shunt settings are figured by comparing the loctal tube with its equivalent in older types, making whatever slight corrections that prove necessary in your personal table.

If the needle goes off scale reduce the shunt setting to give a reading of 90 and correct your table. Remember, however, that new tubes in use for a short time sometimes read higher as the emission temporarily increases so use judgment in making too frequent changes in your table (W8OZV).

The method of adjusting the meter at the scale limits by using auxiliary resistors was previously described by Mr. R. K. Wheeler in RADIO WORLD, and the writer regrets deeply that through oversight an acknowledgment to this effect was omitted in the May article.

—Edward Lindberg.

## Classified

Rate 15c per word. Minimum, 10 words.

### CORRESPONDENCE COURSES

USED Correspondence Courses and Educational Books sold or rented. Inexpensive. Money-back guarantee. Write for Free Catalog listing 4000 bargains. (Courses Bought.) Lee Mountain, Pisgah, Alabama.

### PATENT ATTORNEYS

INVENTORS—Before disclosing your invention to anyone send for Form "Evidence of Conception;" "Schedule of Government and Attorneys' Fees" and instructions. Sent free. Lancaster, Allwine & Rommel, 414 Bowen Building, Washington, D. C.

PATENTS—Advice and booklet free. Highest references. Best results. Promptness assured. Watson E. Coleman. Patent Lawyer, 724 9th Street, Washington, D. C.

### INVENTIONS WANTED

INVENTIONS Commercialized. Patented or unpatented. Write Adam Fisher Company, 278 Enright, St. Louis, Missouri.

### RADIO ENGINEERING

RADIO Engineering, broadcasting, aviation and police radio, servicing, marine and Morse telegraphy taught thoroughly. All expenses low. Catalog free. Dodge's Institute, Elm St., Valparaiso, Ind.

### RADIO

WE buy and sell used radio testing equipment. Harold Davis, Inc., Jackson, Miss.

### SPECIAL RATES FOR READERS

A special classified rate is now offered for readers (non-commercial) who wish to buy, sell, or exchange radio sets, transmitters or parts; 10 words for 50c. Extra words, 15c. Payable in advance.

all available batteries and at great personal risk carried them to his home. When power was wrecked he established the only contact Westerly had with the outside world. With trees falling all around him and houses collapsing, he rigged up temporary antennas and kept his feeble battery-operated transmitter working, while for 46 hours he handled all rescue messages to and from Red Cross National Headquarters, bringing relief to the stricken community, notified relatives of the dead and carried reassuring messages for survivors.

Harold Amers of Pomona, Calif., writes that W9BHP, portable-marine, aboard the S.S. Steelmaker operates daily on 28.501, with a power of 35 watts. He stated he would appreciate reports on signals when in foreign ports, and that these should be sent to his home QRA, from which point they would be forwarded to him.

### SHORT WAVES FOR DX'ers on the WEST COAST

by JOHN D. CLARK

All Times Are PACIFIC STANDARD Straits Settlements Philippines

STATION KZIB (Incidentally, these are the correct call letters as given on QSL card) is making extensive improvements and will shortly broadcast simultaneously on two frequencies, 9.50 meg. and another which has not been decided upon as yet. The present schedule of 11 to 11:45 p.m. and 1 to 6 a.m. will be extended.

An unconfirmed report indicates that KZRM "Radio Manila" is again operating in the 25 meter band—apparently on a simultaneous transmission with the 9.57 meg. frequency. The 25 meter broadcasts must be test transmissions since they are heard only irregularly.

### Indo-China

"Radio Saigon," which made its appearance in the short wave spectrum last month, now seems to be operating on 6.12 meg. until 6:15 a.m. and then shifts to 11.785 meg. This is the mysterious new Oriental which so many listeners have been reporting in the 25 meter band during the past few weeks. As we go to press a last-minute flash indicates that the change-over to 11.785 meg. is now taking place at 5:30 instead of 6:15 a.m. Volume on both frequencies is excellent, and announcements are in both English and French.

"Radio Boy-Landry," also located in Saigon, Indo-China, has been unreported for over two weeks. It is not yet known whether this broadcaster has closed down or whether it is using one of the numerous frequencies now occupied by new unidentified Oriental transmitters.

### Japan

A new station in Taihoku, Taiwan, is relaying the programs of JFAK on approximately 9.69 meg. near 6 a.m. This was at first mistaken by many fans for JFO (9.62 meg.), but a careful check shows that the newcomer is so close to Singapore's ZHP (9.69 meg.) that it even causes a serious heterodyne at times.

Nipponese phones on 6.17 and 6.70 meg. have been logged several times on plain voice near 5:45 a.m.

The powerful Tokyo station on 7.30 meg. is still unidentified. It is often heard with an extremely strong signal near 5:30 a.m., and usually signs off about 6.

JDY of Darien, Kwangtung, is now operating simultaneously on two frequencies. In addition to the 9.92 meg. wave, this Japanese-owned broadcaster is also using a new frequency of 6.13 meg. from 4 to 5 a.m. Programs are relayed from the studios of MTCY. Occasionally, both transmitters remain on the air until 5:30.

JVW3 of Tokyo, although scheduled to operate only from 10:50 to 11:20 p.m. and 1 to 4:40 a.m. has been heard several times near midnight with running commentaries on baseball games and other sporting events. Announcements are made only in Japanese except during the daily English news broadcast at 1:55 a.m.

Schedules for the Nipponese Overseas Broadcasts continue as shown in this column last month.

(Please turn the page)

# Save Money!

With the

## RADOLEK RADIO PROFIT GUIDE!

**164 PAGES**



### EVERYTHING IN RADIO AT LOWEST PRICES!

Radolek offers you the MOST for your money! Lowest Prices! Best Quality! Biggest values! Most complete Stock! Fastest Service! Send for your FREE copy NOW!

**OVER 15,000 REPAIR PARTS**

The world's most complete stock of radio repair parts and exact duplicate replacements. All leading brands. All guaranteed. Lowest Prices!

**COMPLETE TUBE SELECTION**

All types. RCA, Sylvania, Raytheon, Philco, etc. Includes Kellogg, special Majestic types and transmitting tubes. Complete selection.

**NEWEST TEST INSTRUMENTS**

The most complete line ever displayed in any catalog. All leading makes. Latest improved models at lowest prices.

**GREATEST RADIO VALUES**

A Huge selection of super values as low as \$5.20. New Phono-Radio combinations. Automatic tuning sets. Beautiful cabinets. New "Ham" receivers and equipment.

**EVERYTHING FOR AUTO RADIO**

Complete auto radio section. Includes vibrator replacement guide, new auto aerials, custom panel control plates for all autos, newest Auto Sets.

**COMPLETE P. A. SELECTION**

New 1939 public address amplifiers from 10 to 100 watts. Complete P. A. Systems for permanent, Mobile and Portable installations. Best values!

**NEW ELECTRICAL APPLIANCES**

Extra profits for you! Standard Brand Electric Irons, Stoves, Heaters, Percolators, Waffle Irons, Vacuum Cleaners, Trains, Clocks, Mixers, etc., at lowest prices!



**FREE!**

Mail Coupon Catalog

**The RADOLEK Co.**

601 W. Randolph, Chicago  
Dept. B-32

Send the 1939 Radolek Radio Profit Guide FREE.

Name.....

Address.....

Serviceman?  
  Dealer?  
  Experimenter?



# No worries about Humidity with—

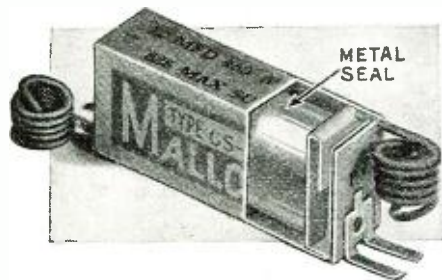

## P. R. MALLORY & CO. Inc. MALLORY CONDENSERS On the Job!

The inside of a Mallory Replacement Condenser never makes the acquaintance of humidity or moisture because Mallory's perfected metal seal never lets them in. This heavy metal seal is around the actual condenser, and inside the carton as shown by the illustration.

This metal seal, together with the final sealing of the outside carton is so impervious to moisture that even immersion in flood waters has failed to affect or change its characteristics.

Yet this is only one feature of Mallory Replacement Condensers. If you are not using Mallorys you still have to meet up with the best condensers there are. Let your distributor know that you want all the dope right now.

**P. R. MALLORY & CO., Inc.**  
INDIANAPOLIS INDIANA  
Cable Address—PELMALLO



### Unidentified

A new and unidentified station has been logged on 6.01 meg. until after 7 a.m. with a man and woman talking alternately. It is extremely close to XYZ of Rangoon, Burma. Oriental music on 7.07 meg. near 5:45 a.m. has been reported by several listeners, but the station usually signs off shortly after 6 o'clock with no announcement.

A great many new Oriental stations have been appearing in all parts of the dial between 3 and 6 a.m. Reports vary as to the exact frequencies, and more definite information will be included in this column next month.

### Tuning Tips

**NORWAY:** LKJ has not been heard on 9.61 meg. lately, and tests on that frequency between 8 and 9 p.m. have evidently been discontinued. However, the new LCN of Jeloy, Norway has been heard testing by west coast listeners on 10.715 meg. about the same hour.

**AUSTRALIA:** VLR3 or Melbourne, Australia, relaying the programs of 3AR, 2CO, and 3GB, has signed off its 11.88 meg. frequency several times at 12:15 a.m. instead of at midnight. Programs are continued on 9.58 meg. after a 15 minute intermission.

**JAVA:** PMN of Bandoeng, Java, signs off at 7:30 with other stations of the Javanese network, but returns to the air with an individual native program on 10.26 meg. at approximately 7:40. The station is still audible as late as 8:30 a.m. . . . The new broadcaster YDD of Sourabaya, Java, is back again on 6.06 meg. after being off the air for several weeks. It relays the regular Javanese network programs, but usually fades out shortly after daybreak.

**INDO-CHINA:** An unconfirmed report indicates that "Radio-Saigon" is audible on its new 11.785 meg. frequency from 8 to 9 p.m. However repeated checks have failed to reveal the Indo-Chinese station at this time of day.

**CHINA:** XOJD of Hankow, China, seems to have vanished almost as soon as it appeared. The station was heard only for a short time on 6.88 meg. near 5 a.m. and was last logged May 20. Chinese phones XTU (12.07 meg.), XTS (11.38 meg.), and XTJ (11.69 meg.) are being heard quite regularly now near 5 or 6 a.m.

This month we inaugurate a new section of "Short Waves in the West"—a "Let's Listen" section. Our observations indicate that a large percentage of listeners are interested in reception of certain particular countries, and it is the purpose of this section to show hour by hour west coast reception from individual foreign countries. A few countries will be covered in this manner each month.

ZBW, Hongkong, China—Announces almost entirely in English.

XGOX and XGOY, Chungking, China—Announces in English and Chinese.

XPSA, Kwei Yang, China—Announces Chinese; occasional English.

CRY9, Macao, China—Announces Portuguese, Chinese, English.

XOJD, Hankow, China—Chinese. only

XOY, Chengtu, China—Chinese. only

Midnight—None audible.

1 a.m.—ZBW (9.53 meg. fair).

2 a.m.—ZBW (9.53 meg. fair); XPSA (6.98 meg. fair).

3 a.m.—ZBW (9.53 meg. fair); XPSA (6.98 meg. good).

4 a.m.—ZBW (9.53 meg. good); XPSA (6.98 meg. good); XGOY (11.9 meg. fair); XOJD (6.88 meg. weak).

5 a.m.—ZBW (9.53 meg. good); XPSA (6.98 meg. good); XGOY (11.9 meg. good); XOJD (6.88 meg. weak).

6 a.m.—ZBW (9.53 meg. good); XPSA (6.98 meg. good); XGOY (11.9 meg. good); CRY9 (6.08 meg. Mon. only).

7 a.m.—XPSA (6.98 meg. good); XGOY (11.9 meg. good); XOY (9.32 meg. weak).

8 a.m. to 6 p.m.—None audible.

7 p.m.—XGOX (17.8 meg. fair).

8 p.m. to midnight—None audible.

### Let's Listen to . . . Japan

JZJ, JZK, JLG3, JZL, JLT2, JLU3, Tokyo, Japan—Overseas stations announcing in both English and Japanese.

JVH, JVV3—Network relay stations announcing only Japanese.

Midnight—JVV3 (11.73 meg. good but irregular).

1 a.m.—JVV3 (11.73 meg. good).

2 a.m.—JVV3 (11.73 meg. good).

3 a.m.—JVV3 (11.73 meg. good).

4 a.m.—JVV3 (11.73 meg. good); JZK (15.16 meg. good); JZJ (11.8 meg. good).

5 a.m.—JZJ (11.8 meg. good); JZK (15.16 meg. good); JLU3 (15.135 meg. good).

6 a.m.—JZJ (11.8 meg. good); JZK (15.16 meg. good).

7 to 11 a.m.—None audible.

Noon—JLG3 (11.71 meg. fair); JZK (15.16 meg. weak).

1 p.m.—JLG3 (11.71 meg. weak); JZK (15.16 meg. weak).

2 p.m.—JZL (17.78 meg. good); JLG3 (11.71 meg. weak).

3 p.m.—None audible.

4 p.m.—JVH (14.6 meg. fair but irregular).

5 p.m.—JZL (17.79 meg. good).

6 p.m.—VH (14.6 meg. fair but irregular).

7 p.m.—VH (14.6 meg. fair).

8 p.m.—None audible.

9 p.m.—JZK (15.16 meg. after 9:30).

10 p.m.—JZK (15.16 meg. good).

11 p.m.—JVV3 (11.73 meg. fair 10:50 to 11:20).

### Let's Listen to . . . India

VUD2, Delhi, India—Announces English and native.

VUB2, Bombay, India—Announces English and native.

VUM2, Madras, India—Announces native only.

VUC2, Calcutta, India—Announces English and native.

Midnight—None audible.

1 a.m.—VUM2 (11.87 meg. weak).

2 a.m.—None audible.

3 a.m.—VUC2 (9.525 meg. weak).

4 a.m.—VUD2 (9.59 meg. good); VUC2 (4.92 meg. weak); VUB2 (4.90 meg. weak).

5 a.m.—VUD2 (9.59 meg. good); VUC2 (4.92 meg. weak); VUB2 (4.90 meg. weak).

6 a.m.—VUD2 (9.59 meg. good).

7 a.m.—VUD2 (9.59 meg. fair).

8 a.m.—VUD2 (9.59 meg. weak).

9 a.m. to 6:30 p.m.—None audible.

7 p.m.—VUD3 (15.29 meg. fair).

8 p.m.—VUD3 (15.29 meg. weak).

9 p.m.—None audible.

10 p.m.—None audible.

11 p.m.—VUB2 (9.55 meg. weak but irregular).

### Let's Listen to . . . Siberia

RV15, Khabarovsk, U.S.S.R.—Announces Russian and Chinese.

Midnight to 2 a.m.—RV15 (4.27 meg. fair).

2 a.m. to 6 a.m.—RV15 (4.27 meg. good).

6 a.m. to 7 a.m.—RV15 (4.27 meg. weak).

7 a.m. to 11 p.m.—None audible.

11 p.m.—RV15 (4.27 meg. weak).

### Let's Listen to . . . Indo-China

"Radio-Saigon," Saigon, Indo-China—Announces French and Chinese.

"Radio Boy-Landry," Saigon, Indo-China—Announces French, Chinese and English.

"Radio-Hanoi," Hanoi, Indo-China—Announces French and Chinese.

Midnight to 3 a.m.—None audible.

3 a.m.—"Radio Saigon" (6.12 meg. good); "Radio Hanoi" (9.51 and 11.9 meg. weak but irregular).

4 a.m.—"Radio Saigon" (6.12 meg. good); "Radio Hanoi" (9.51 and 11.9 meg. weak, but irregular); "Radio Boy-Landry" (6.20 meg. fair).

5 a.m.—"Radio Saigon" (6.12 meg. good); "Radio Boy-Landry" (6.20 meg. fair).

6 a.m.—"Radio Saigon" (11.79 meg. good); "Radio Boy-Landry" (6.20 meg. fair).

7 a.m.—"Radio Saigon" (11.79 meg. fair).

8 a.m. to 7 p.m.—None Audible.

8 p.m.—"Radio Saigon" (11.79 meg. weak but irregular).

# Camera Fans!

**WIN** **\$3,700** **OVER**  
**PRIZES**

## IN TWO CLASSES COLOR ... BLACK & WHITE

No camera owner, amateur or professional can afford to miss this contest, the largest ever held by any photographic magazine. Huge cash prizes and valuable photographic equipment for your pictures. Make your hobby pay dividends. Enter this giant contest now! Your best picture may win a prize.

### OVER \$1500 PRIZES

*For Color Photographs*

**\$500** . CASH. 1st PRIZE  
In Color Class

**\$361** . COLOR CAMERA      2nd PRIZE  
A genuine Curtis  
Colorscout one-  
shot camera

#### OTHER OUTSTANDING PRIZES

\$150 Lerochrome single mirror color camera. \$112.50 Spectra color camera. Many other merchandise and cash prizes.

### OVER \$2100 PRIZES

*For Black & White Photographs*

**\$500** . CASH. 1st PRIZE  
In Black & White Class

**\$250** . CASH. 2nd PRIZE

#### OTHER VALUABLE AWARDS

\$158 Rolleiflex camera. 140 other merchandise prizes ranging from \$62.50 to \$2.50. Enlargers, cameras, exposure meters, flash outfits, tripods, range finders, etc.

**COMPLETE DETAILS IN THE AUGUST ISSUE**

**25c**  
At Your  
Newsstand

**Popular  
Photography**

**NOW  
ON  
SALE**



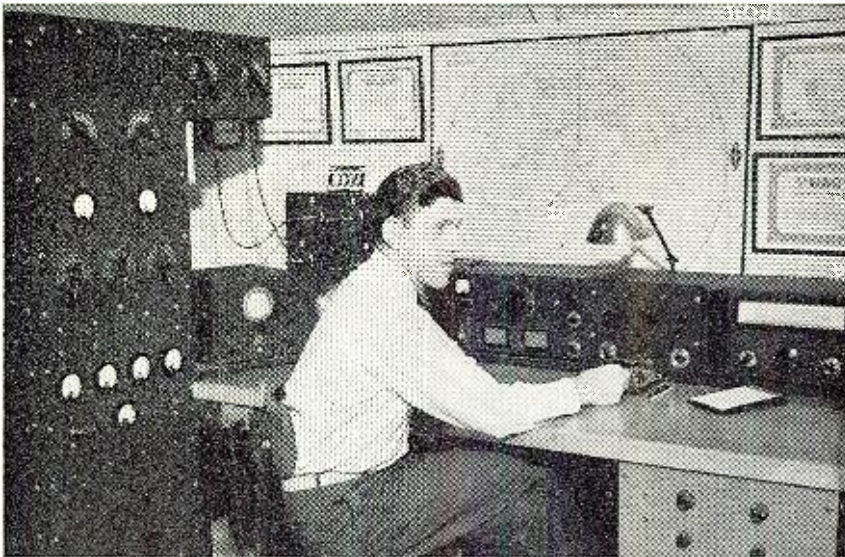

**"..AND THE MEISSNER  
SIGNAL SHIFTER  
IS DIRECTLY  
RESPONSIBLE FOR  
MY SUCCESS"—says  
W.M. "Bill" Atkins  
W9TJ**

No wonder Bill Atkins—operator of W9TJ since 1921—is enthusiastic over the Meissner SIGNAL SHIFTER.

He was FIFTH in the 1939 International Radiotelegraph DX contest with 159,372\* points, contacting 85 different countries in the allotted 90 hours (the highest score ever turned in by an inland station in the United States) and official WORLD HIGH scorer in the 1938 Australian-New Zealand DX contest—also contacted 67 South Africans in the recent SARRL DX contest—using the SIGNAL SHIFTER as the frequency control of his kilowatt CW transmitter operating on the 28, 14 and 7 megacycle bands. But we'll let Bill tell you in his own words:

*"The Signal Shifter is set up with operation and output on 7 MC. To change from Xtal to ECO, it is only necessary to remove the crystal and plug in a coil, linked to the Signal Shifter. The transmitter is so arranged that on 14 Mc, a range of 150 Kc may be used on the Signal Shifter WITHOUT touching a single control on the transmitter! In other words, I can utilize the complete range of say from 14,250 to 14,440 Kc merely by tuning the Signal Shifter.*

*"This shows the COMPLETE flexibility here at W9TJ and this flexibility is ENTIRELY responsible for the OUT-*

*STANDING performance of this station. When I say that FLEXIBILITY is the most important thing I speak from experience. Last year with exactly the same transmitter, using crystal control on a few frequencies, and with CONDITIONS IDEAL, my score in this contest was 42,000 points. This year with completely flexible operation of the same equipment, flexibility being provided by the Signal Shifter, my score was FOUR TIMES that of last year! I can take no credit for this increase other than for actually pounding out the code. In all sincerity, I must say that the Signal Shifter is DIRECTLY responsible for results obtained in this contest. The facts are obvious. Also I classified the Tone Reports received since installing the Signal Shifter. Combined results of 3 major contests show 494 reports of T9 (purest DC tone) and 9 reports of T8 (good DC tone). This I consider not only completely acceptable but highly complimentary to the Meissner Signal Shifter."*

*W.M. "Bill" Atkins*

The Meissner Signal Shifter (regular model \$39.95 NET, De luxe Model \$44.95 NET) is completely assembled, wired, adjusted. It is ready for use (except for tubes) when you buy it. Ask your Parts Jobber for a DEMONSTRATION! Mail coupon below.

## W9TJ MAKES FINE SHOWING IN THREE MAJOR CONTESTS

**1938 AUSTRALIAN-NEW ZEALAND DX CONTEST**—19,740 POINTS—(118 Contacts) World's Highest Score.

**1939 SOUTH AFRICAN DX CONTEST**—104,520 POINTS—(67 contacts) far ahead of nearest competitor.\*

**1939 INTERNATIONAL DX CONTEST**—159,372 POINTS—(318 contacts) highest ever made by an inland station.\*

Paste on 1¢ Postcard or Mail in Envelope

MEISSNER MANUFACTURING COMPANY  
Mt. Carmel, Illinois, Dept. N-8

Rush data explaining How and Why the Meissner Signal Shifter will improve results for me.

Name.....  
Street.....  
City..... State.....

\* reported, but not yet official.

